

ROUND CABLE EMI CORES / LF TYPE

FEATURES

- ◆ Easy installation
- ◆ Internal dimensions are from 4mm to 19 mm radius.
- ◆ The smooth surface prevents damage to wire insulation.



APPLICATIONS

- ◆ Internal and external power cables
- ◆ Internal cables between pc boards and data connectors
- ◆ Computer peripherals, for example digital camera, DVD, fax machine, monitor, printer, and power supply cables

ORDERING CODE

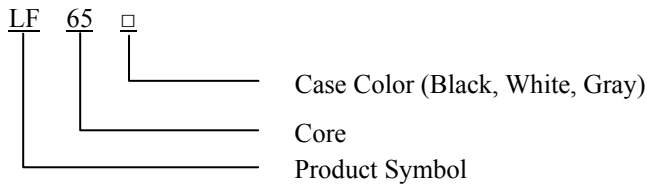

SHAPES

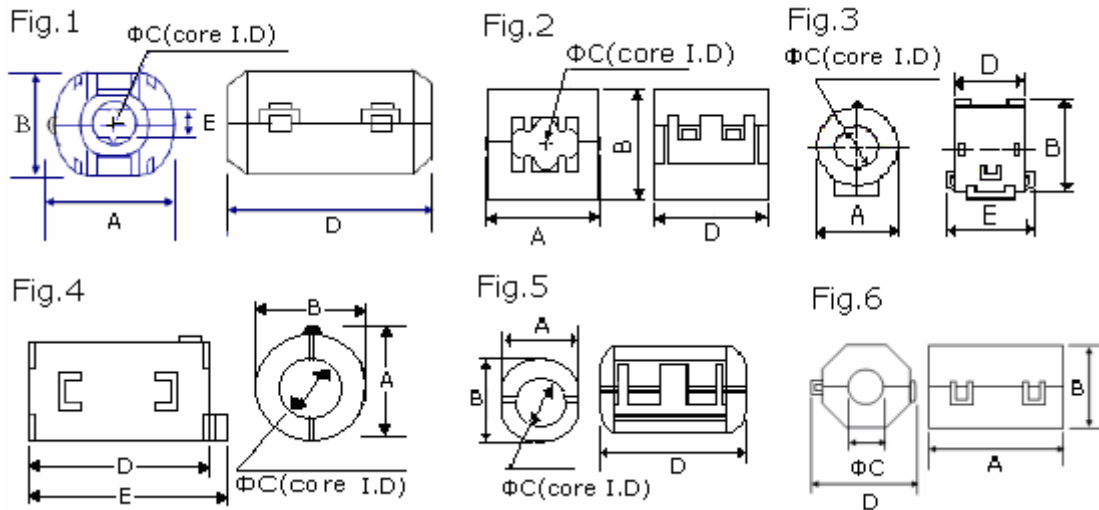

DIMENSIONS (UNIT:mm)



CORE MASTER ENTERPRISE CO., LTD.

<http://www.coremaster.com.tw>

ROUND CABLE EMI CORES / LF TYPE

Part No.	Fig.	A (±1)	B (±1)	C (±0.5)	D (±1)	E (±1)	Impedance (Ω) Min		Use Cable Dia. Max
							25 MHz	100 MHz	
LF 35	5	15.0	15.0	4.0	25.2	---	55	95	Φ4
LF 50	5	16.5	16.5	5.2	29.5	---	70	120	Φ5
LF 501	2	15.0	14.0	5.2	23.0	---	70	120	Φ5
LF 502	1	13.0	11.8	5.0	25.5	---	60	100	Φ5
LF 503	1	17.0	15.0	5.2	30.0	---	130	210	Φ5
LF 60	6	18.5	14.0	6.0	15.5	---	60	80	Φ6
LF 65	2	20.5	20.0	6.5	33.0	---	120	200	Φ6.5
LF 70	4	15.5	14.0	7.0	18.0	22.0	40	75	Φ7
LF 702	1	17.0	15.0	7.0	30.0	---	70	130	Φ7
LF 75	5	21.0	21.0	7.5	39.0	---	90	150	Φ7.5
LF 801	3	19.5	23.0	8.1	17.0	23.0	42	85	Φ8
LF 802	3	19.5	23.0	8.1	20.0	26.0	50	110	Φ8
LF 90									
LF 901	4	20.5	19.5	9.0	31.5	35.5	80	130	Φ9
LF 902	1	19.5	18.0	9.0	35.0	---	80	130	Φ9
CT 0933	1	22.5	22.5	9.5	43.0	---	105	190	Φ9.5
CT 0933-2B	1	22.0	23.5	12.2	43.0	---	100	180	Φ12
LF 100	2	25.5± 1.0	23.5± 1.0	10.0± 0.5	33.0± 1.0	---	80	130	Φ10
LF 101	3	24.5± 1.0	28.5± 1.0	10.2± 0.5	13.5± 1.0	20.0± 1.0	35	75	Φ10
LF 102	1	21.5± 1.0	20.0± 1.0	10.0± 1.0	35.0± 1.0	---	144	240	Φ10
LF 103	4	20.5± 1.0	20.5± 1.0	10.0± 0.5	32.0± 1.0	36.0± 1.0	100	160	Φ10
LF 110	4	20.5± 1.0	21.0± 1.0	11.0± 0.5	32.0± 1.0	36.0± 1.0	60	110	Φ11
LF 1101	1	21.0± 1.0	20.0± 1.0	11.0± 0.5	36.0± 1.0	---	80	170	Φ11
LF 120	3	28.0± 1.0	32.0± 1.0	11.5± 0.5	18.0± 1.0	24.0± 1.0	50	100	Φ11.5
LF 130	2	32.5± 1.0	30.0± 1.0	13.0± 0.5	33.0± 1.0	---	105	170	Φ13
LF 1301	1	23.5± 1.0	22.5± 1.0	13.0± 0.5	36.0± 1.0	---	70	120	Φ13
LF 1302	4	31.5± 1.0	30.5± 1.0	13.0± 0.5	34.0± 1.0	39.5± 1.0	80	130	Φ13
LF 150	3	29.0± 1.0	33.0± 1.0	15.0± 0.5	15.5± 1.0	21.5± 1.0	30	70	Φ15
LF 190	2	29.5± 1.0	29.4± 1.0	19.4± 0.5	42.0± 1.0	---	90	160	Φ19



CORE MASTER ENTERPRISE CO., LTD.

<http://www.coremaster.com.tw>

ROUND CABLE EMI CORES / LF TYPE

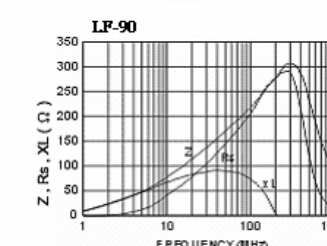
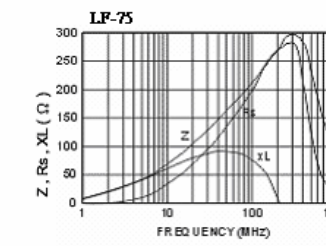
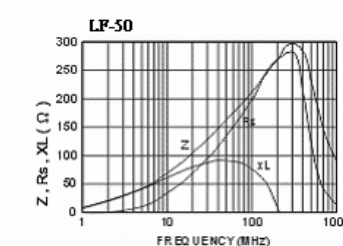
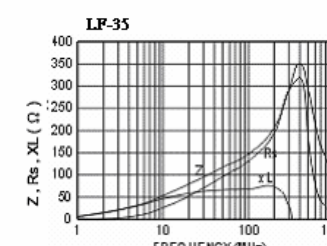
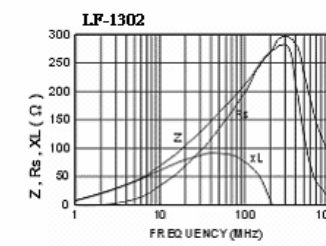
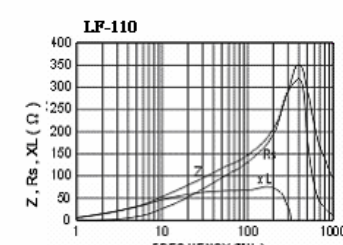
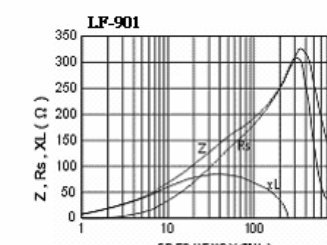
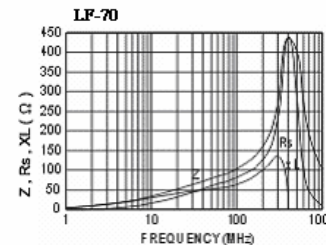
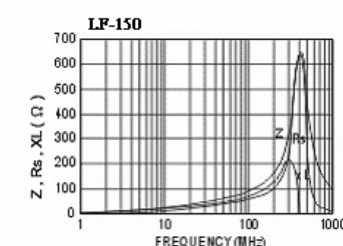
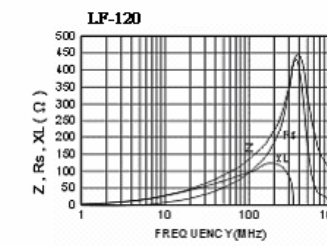
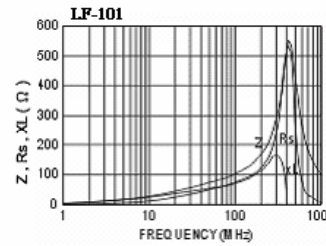
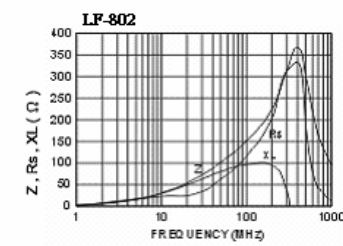
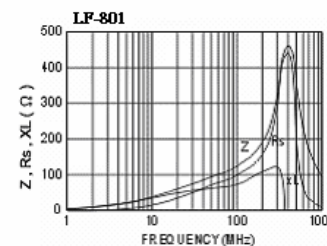
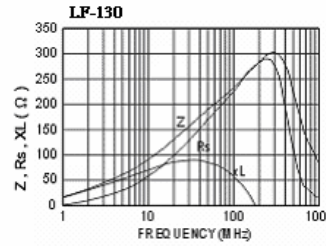
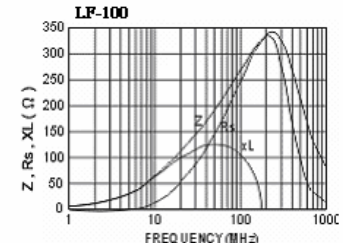
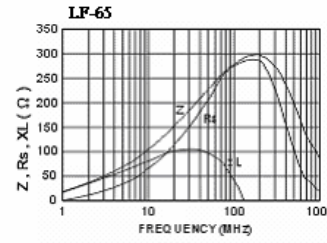
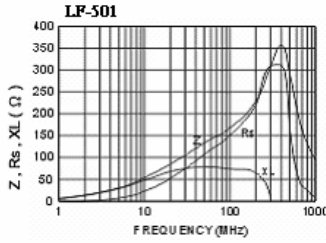
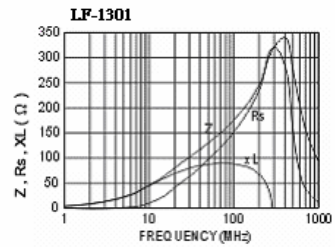
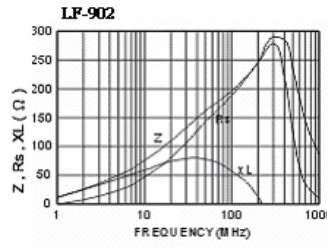
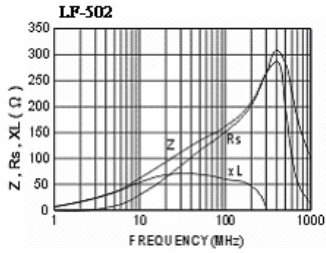

CORE MASTER ENTERPRISE CO., LTD.

<http://www.coremaster.com.tw>