

UNSHIELDED SMD POWER INDUCTORS / TPY TYPE

FEATURES

- ◆ Surface mount inductor with high current rating.
- ◆ Low resistance to keep power loss minimum.



APPLICATIONS

- ◆ Power supply for VTRs.
- ◆ Portable communication equipment.
- ◆ Notebook PCs.
- ◆ LCD televisions.
- ◆ DC/DC converters, etc.

ORDERING CODE

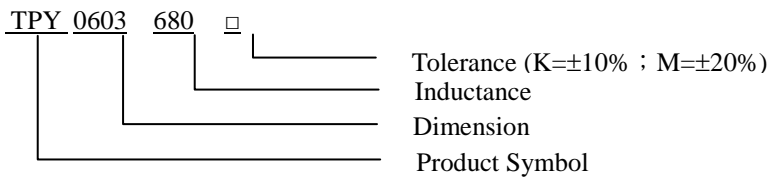

SHAPES

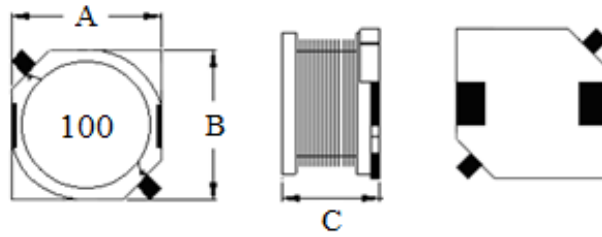

Fig 1.

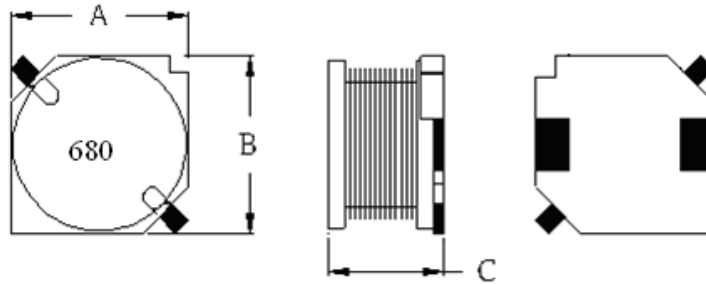

Fig 2.

DIMENSIONS (UNIT:mm)

Part No.	Fig.	A	B	C
TPY 0603	1	6.0 ± 0.2	6.0 ± 0.2	3.0 ± 0.2
TPY 0703	2	7.0 ± 0.3	7.0 ± 0.3	3.0 ± 0.3
TPY 0705	2	7.0 ± 0.3	7.0 ± 0.3	4.6 ± 0.3



CORE MASTER ENTERPRISE CO., LTD.

<http://www.coremaster.com.tw>

UNSHIELDED SMD POWER INDUCTORS / TPY TYPE

ELECTRICAL CHARACTERISTICS FOR TPY0603

Part No.	Inductance (μ H)	RDC (Ω) MAX	IDC (A) MAX
TPY0603-4R7 □	4.7	0.065	1.85
TPY0603-6R8 □	6.8	0.090	1.55
TPY0603-100 □	10	0.115	1.30
TPY0603-150 □	15	0.180	1.10
TPY0603-220 □	22	0.250	0.98
TPY0603-330 □	33	0.380	0.83
TPY0603-470 □	47	0.430	0.68
TPY0603-560 □	56	0.620	0.63
TPY0603-680 □	68	0.710	0.58
TPY0603-820 □	82	0.730	0.48
TPY0603-101 □	100	1.050	0.42

ELECTRICAL CHARACTERISTICS FOR TPY0703

Part No.	Inductance (μ H)	RDC (Ω) MAX	IDC (A) MAX
TPY0703-3R3 □	3.3	0.042	2.20
TPY0703-4R7 □	4.7	0.055	2.00
TPY0703-6R8 □	6.8	0.065	1.60
TPY0703-100 □	10	0.080	1.40
TPY0703-150 □	15	0.120	1.10
TPY0703-220 □	22	0.150	1.00
TPY0703-330 □	33	0.230	0.85
TPY0703-470 □	47	0.310	0.70
TPY0703-560 □	56	0.390	0.65
TPY0703-680 □	68	0.430	0.60
TPY0703-820 □	82	0.490	0.50
TPY0703-101 □	100	0.650	0.45
TPY0703-151 □	150	0.850	0.35
TPY0703-221 □	220	1.250	0.30

CORE MASTER ENTERPRISE CO., LTD.



<http://www.coremaster.com.tw>

UNSHIELDED SMD POWER INDUCTORS / TPY TYPE

ELECTRICAL CHARACTERISTICS FOR TPY0705

Part No.	Inductance (μ H)	RDC (Ω) MAX	IDC (A) MAX
TPY0705-3R3 □	3.3	0.040	2.70
TPY0705-4R7 □	4.7	0.050	2.50
TPY0705-6R8 □	6.8	0.060	2.20
TPY0705-100 □	10	0.075	2.00
TPY0705-150 □	15	0.090	1.50
TPY0705-220 □	22	0.120	1.30
TPY0705-330 □	33	0.180	1.10
TPY0705-470 □	47	0.220	0.90
TPY0705-560 □	56	0.250	0.85
TPY0705-680 □	68	0.270	0.80
TPY0705-820 □	82	0.380	0.70
TPY0705-101 □	100	0.420	0.65
TPY0705-151 □	150	0.580	0.50
TPY0705-221 □	220	0.880	0.40
TPY0705-331 □	330	1.100	0.32
TPY0705-471 □	470	2.100	0.28
TPY0705-561 □	560	2.200	0.25
TPY0705-681 □	680	2.500	0.22
TPY0705-821 □	820	2.900	0.20
TPY0705-102 □	1000	4.000	0.18

* Test Frequency : 100KHZ/0.1V



CORE MASTER ENTERPRISE CO., LTD.

<http://www.coremaster.com.tw>

UNSHIELDED SMD POWER INDUCTORS / FPI TYPE

FEATURES

- ◆ Silver Plated Type
- ◆ High power and high saturation
- ◆ Ideal inductors for DC/DC conversion



APPLICATIONS

- ◆ Power supply for VTRs.
- ◆ Portable communication equipment.
- ◆ Notebook PCs.
- ◆ LCD televisions.
- ◆ DC/DC converters, etc.

ORDERING CODE

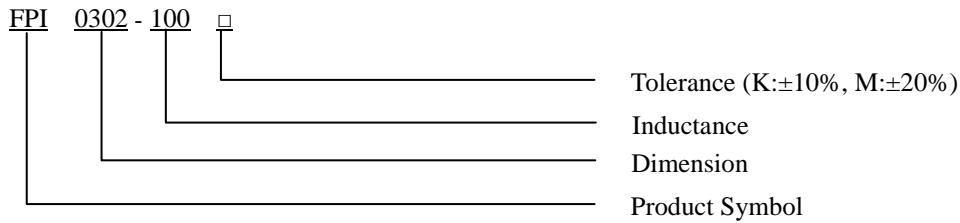

SHAPES

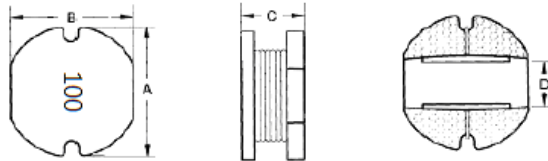

DIMENSIONS (UNIT: mm)

Part No.	A	B	C	D (Ref.)
FPI 0311	3.3 ± 0.3	3.0 ± 0.3	1.1 ± 0.3	1.0
FPI 0315	3.3 ± 0.3	3.0 ± 0.3	1.5 ± 0.3	1.0
FPI 0302	3.3 ± 0.3	3.0 ± 0.3	2.1 ± 0.3	1.0
FPI 0402	4.5 ± 0.3	4.0 ± 0.3	2.1 ± 0.3	1.3
FPI 0403	4.5 ± 0.3	4.0 ± 0.3	3.2 ± 0.3	1.3
FPI 0519	5.8 ± 0.3	5.2 ± 0.3	2.1 ± 0.3	1.3
FPI 0502	5.8 ± 0.3	5.2 ± 0.3	2.5 ± 0.3	1.3
FPI 0503	5.8 ± 0.3	5.2 ± 0.3	3.0 ± 0.5	1.3
FPI 0504	5.8 ± 0.3	5.2 ± 0.3	4.5 ± 0.3	1.3
FPI 0703	7.8 ± 0.3	7.0 ± 0.3	3.5 ± 0.3	2.1
FPI 0705	7.8 ± 0.3	7.0 ± 0.3	5.0 ± 0.3	2.1
FPI 0706	7.8 ± 0.3	7.0 ± 0.3	6.2 ± 0.3	2.6
FPI 0707	7.8 ± 0.3	7.0 ± 0.3	7.0 ± 0.3	2.6
FPI 1004	10.0 ± 0.3	9.0 ± 0.3	4.0 ± 0.3	3.1
FPI 1005	10.0 ± 0.4	9.0 ± 0.4	5.4 ± 0.3	3.1
FPI 1006	10.0 ± 0.4	9.0 ± 0.4	6.5 ± 0.3	3.1
FPI 1008	10.0 ± 0.4	9.0 ± 0.4	8.2 ± 0.3	3.1
FPI 1206	13.0 ± 0.5	13.0 ± 0.5	7.0 ± 0.3	4.5

CORE MASTER ENTERPRISE CO., LTD.



<http://www.coremaster.com.tw>

UNSHIELDED SMD POWER INDUCTORS / FPI TYPE

ELECTRICAL CHARACTERISTICS FOR FPI0311

Part No.	Inductance (uH)	RDC (Ω) MAX	IDC (A) MAX
FPI0311-1R0 □	1.0	0.060	2.00
FPI0311-2R2 □	2.2	0.130	1.70
FPI0311-2R7 □	2.7	0.150	1.35
FPI0311-3R3 □	3.3	0.170	1.25
FPI0311-4R7 □	4.7	0.300	1.20
FPI0311-6R8 □	6.8	0.420	1.00
FPI0311-100 □	10	0.800	0.82
FPI0311-220 □	22	1.500	0.60
FPI0311-330 □	33	1.550	0.45

ELECTRICAL CHARACTERISTICS FOR FPI0315

Part No.	Inductance (uH)	RDC (Ω)	IDC (A)
FPI0315-1R0 □	1.0	0.060	3.20
FPI0315-2R2 □	2.2	0.100	2.20
FPI0315-3R3 □	3.3	0.150	1.80
FPI0315-4R7 □	4.7	0.170	1.55
FPI0315-5R6 □	5.6	0.210	1.30
FPI0315-6R8 □	6.8	0.230	1.10
FPI0315-8R2 □	8.2	0.260	1.00
FPI0315-100 □	10	0.300	0.90
FPI0315-150 □	15	0.560	0.80
FPI0315-470 □	47	1.500	0.50
FPI0315-101 □	100	3.100	0.30

ELECTRICAL CHARACTERISTICS FOR FPI0302

Part No.	Inductance (uH)	RDC (Ω)	IDC (A)
FPI0302-1R0 □	1.0	0.054	4.00
FPI0302-2R2 □	2.2	0.120	2.50
FPI0302-3R3 □	3.3	0.160	2.30
FPI0302-4R7 □	4.7	0.200	2.20
FPI0302-5R6 □	5.6	0.210	1.70
FPI0302-6R8 □	6.8	0.350	1.50
FPI0302-8R2 □	8.2	0.290	1.45
FPI0302-100 □	10	0.360	1.40
FPI0302-120 □	12	0.387	1.20
FPI0302-150 □	15	0.450	1.13
FPI0302-180 □	18	0.490	0.90
FPI0302-220 □	22	0.600	0.85
FPI0302-270 □	27	0.750	0.80
FPI0302-330 □	33	1.550	0.75
FPI0302-390 □	39	2.150	0.70

CORE MASTER ENTERPRISE CO., LTD.

<http://www.coremaster.com.tw>



UNSHIELDED SMD POWER INDUCTORS / FPI TYPE

ELECTRICAL CHARACTERISTICS FOR FPI0302

Part No.	Inductance (uH)	RDC (Ω)	IDC (A)
FPI0302-470 □	47	2.300	0.65
FPI0302-560 □	56	2.450	0.60
FPI0302-680 □	68	2.500	0.50
FPI0302-820 □	82	2.700	0.40
FPI0302-101 □	100	3.000	0.35
FPI0302-121 □	120	3.200	0.30
FPI0302-151 □	150	3.600	0.28
FPI0302-181 □	180	5.780	0.26
FPI0302-221 □	220	7.000	0.25
FPI0302-271 □	270	7.580	0.24
FPI0302-331 □	330	8.450	0.23
FPI0302-391 □	390	9.480	0.22
FPI0302-471 □	470	10.800	0.21
FPI0302-561 □	560	17.000	0.12
FPI0302-102 □	1000	34.500	0.11

ELECTRICAL CHARACTERISTICS FOR FPI0402

Part No.	Inductance (uH)	RDC (Ω)	IDC (A)
FPI0402-1R0 □	1.0	0.020	5.40
FPI0402-1R5 □	1.5	0.025	4.57
FPI0402-2R2 □	2.2	0.036	3.50
FPI0402-3R3 □	3.3	0.051	2.80
FPI0402-4R7 □	4.7	0.063	2.60
FPI0402-6R8 □	6.8	0.108	2.05
FPI0402-100 □	10	0.140	1.70
FPI0402-150 □	15	0.230	1.35
FPI0402-220 □	22	0.360	1.17
FPI0402-330 □	33	0.530	0.94
FPI0402-470 □	47	0.760	0.79
FPI0402-680 □	68	0.860	0.65
FPI0402-101 □	100	1.310	0.54

CORE MASTER ENTERPRISE CO., LTD.

<http://www.coremaster.com.tw>



UNSHIELDED SMD POWER INDUCTORS / FPI TYPE

ELECTRICAL CHARACTERISTICS FOR FPI0403

Part No.	Inductance (uH)	RDC (Ω)	IDC (A)
FPI0403-1R0 □	1.0	0.049	4.50
FPI0403-2R2 □	2.2	0.065	3.70
FPI0403-3R3 □	3.3	0.087	3.00
FPI0403-4R7 □	4.7	0.094	2.40
FPI0403-5R6 □	5.6	0.150	2.20
FPI0403-6R8 □	6.8	0.160	1.90
FPI0403-8R2 □	8.2	0.170	1.80
FPI0403-100 □	10	0.182	1.50
FPI0403-120 □	12	0.210	1.40
FPI0403-150 □	15	0.235	1.30
FPI0403-180 □	18	0.340	1.20
FPI0403-220 □	22	0.450	1.00
FPI0403-270 □	27	0.520	0.90
FPI0403-330 □	33	0.600	0.85
FPI0403-390 □	39	0.680	0.80
FPI0403-470 □	47	0.770	0.70
FPI0403-560 □	56	0.830	0.58
FPI0403-680 □	68	1.030	0.55
FPI0403-820 □	82	1.220	0.50
FPI0403-101 □	100	1.340	0.48
FPI0403-121 □	120	1.460	0.45
FPI0403-151 □	150	1.850	0.40
FPI0403-181 □	180	2.180	0.35
FPI0403-221 □	220	3.530	0.33
FPI0403-271 □	270	3.840	0.30
FPI0403-331 □	330	4.200	0.25
FPI0403-391 □	390	4.300	0.23
FPI0403-471 □	470	7.000	0.20
FPI0403-561 □	560	8.500	0.18
FPI0403-102 □	1000	15.000	0.16

CORE MASTER ENTERPRISE CO., LTD.

<http://www.coremaster.com.tw>



UNSHIELDED SMD POWER INDUCTORS / FPI TYPE

ELECTRICAL CHARACTERISTICS FOR FPI0519

Part No.	Inductance (uH)	RDC (Ω)	IDC (A)
FPI0519-1R0 □	1.0	0.035	5.70
FPI0519-2R2 □	2.2	0.062	4.20
FPI0519-3R9 □	3.9	0.073	3.30
FPI0519-4R7 □	4.7	0.080	2.50
FPI0519-6R8 □	6.8	0.160	2.40
FPI0519-100 □	10	0.180	1.80
FPI0519-220 □	22	0.450	1.20
FPI0519-470 □	47	0.750	0.80
FPI0519-560 □	56	0.800	0.60
FPI0519-680 □	68	1.150	0.55
FPI0519-101 □	100	1.500	0.50
FPI0519-151 □	150	2.000	0.45
FPI0519-181 □	180	2.500	0.40

ELECTRICAL CHARACTERISTICS FOR FPI0502

Part No.	Inductance (uH)	RDC (Ω)	IDC (A)
FPI0502-1R5 □	1.5	0.048	5.50
FPI0502-2R2 □	2.2	0.060	5.00
FPI0502-3R3 □	3.3	0.070	3.60
FPI0502-4R7 □	4.7	0.075	2.80
FPI0502-5R6 □	5.6	0.150	2.70
FPI0502-6R8 □	6.8	0.160	2.50
FPI0502-100 □	10	0.180	2.10
FPI0502-150 □	15	0.220	1.90
FPI0502-220 □	22	0.390	1.25
FPI0502-330 □	33	0.430	1.05
FPI0502-470 □	47	0.720	1.00
FPI0502-560 □	56	0.800	0.75
FPI0502-680 □	68	1.000	0.70
FPI0502-820 □	82	1.200	0.70
FPI0502-101 □	100	1.300	0.68
FPI0502-151 □	150	1.810	0.55
FPI0502-221 □	220	3.500	0.46
FPI0502-331 □	330	4.000	0.40
FPI0502-471 □	470	5.000	0.35
FPI0502-561 □	560	5.900	0.32
FPI0502-681 □	680	8.000	0.20

UNSHIELDED SMD POWER INDUCTORS / FPI TYPE

ELECTRICAL CHARACTERISTICS FOR FPI0503

Part No.	Inductance (uH)	RDC (Ω)	IDC (A)
FPI0503-1R0 □	1.0	0.030	10.00
FPI0503-2R2 □	2.2	0.040	5.10
FPI0503-2R7 □	2.7	0.050	4.80
FPI0503-3R3 □	3.3	0.065	4.00
FPI0503-4R7 □	4.7	0.070	2.90
FPI0503-5R6 □	5.6	0.090	2.80
FPI0503-6R8 □	6.8	0.092	2.60
FPI0503-8R2 □	8.2	0.095	2.40
FPI0503-100 □	10	0.170	2.20
FPI0503-120 □	12	0.180	2.10
FPI0503-150 □	15	0.200	2.00
FPI0503-180 □	18	0.210	1.70
FPI0503-220 □	22	0.300	1.50
FPI0503-270 □	27	0.315	1.30
FPI0503-330 □	33	0.380	1.10
FPI0503-390 □	39	0.400	0.95
FPI0503-470 □	47	0.500	0.90
FPI0503-560 □	56	0.700	0.80
FPI0503-680 □	68	1.000	0.75
FPI0503-820 □	82	1.050	0.73
FPI0503-101 □	100	1.100	0.70
FPI0503-121 □	120	1.200	0.63
FPI0503-151 □	150	1.500	0.56
FPI0503-181 □	180	1.800	0.53
FPI0503-221 □	220	2.500	0.48
FPI0503-271 □	270	2.600	0.43
FPI0503-331 □	330	3.000	0.38
FPI0503-471 □	470	3.800	0.37
FPI0503-561 □	560	4.700	0.33
FPI0503-102 □	1000	8.000	0.26

CORE MASTER ENTERPRISE CO., LTD.



<http://www.coremaster.com.tw>

UNSHIELDED SMD POWER INDUCTORS / FPI TYPE

ELECTRICAL CHARACTERISTICS FOR FPI0504

Part No.	Inductance (uH)	RDC (Ω)	IDC (A)
FPI0504-1R0 □	1.0	0.020	7.70
FPI0504-1R5 □	1.5	0.025	6.00
FPI0504-2R2 □	2.2	0.035	5.20
FPI0504-2R7 □	2.7	0.045	5.00
FPI0504-3R3 □	3.3	0.050	4.20
FPI0504-3R9 □	3.9	0.055	4.00
FPI0504-4R7 □	4.7	0.060	3.00
FPI0504-5R6 □	5.6	0.065	2.90
FPI0504-6R8 □	6.8	0.068	2.70
FPI0504-8R2 □	8.2	0.070	2.50
FPI0504-100 □	10	0.100	2.30
FPI0504-120 □	12	0.120	2.20
FPI0504-150 □	15	0.140	2.10
FPI0504-180 □	18	0.150	2.00
FPI0504-220 □	22	0.180	1.50
FPI0504-270 □	27	0.200	1.40
FPI0504-330 □	33	0.230	1.20
FPI0504-390 □	39	0.300	1.10
FPI0504-470 □	47	0.310	1.00
FPI0504-560 □	56	0.420	0.85
FPI0504-680 □	68	0.460	0.80
FPI0504-820 □	82	0.600	0.77
FPI0504-101 □	100	0.700	0.70
FPI0504-121 □	120	0.930	0.65
FPI0504-151 □	150	1.100	0.58
FPI0504-181 □	180	1.350	0.55
FPI0504-221 □	220	1.570	0.50
FPI0504-271 □	270	1.850	0.47
FPI0504-331 □	330	2.000	0.45
FPI0504-391 □	390	2.200	0.42
FPI0504-471 □	470	3.000	0.40
FPI0504-561 □	560	3.000	0.35
FPI0504-681 □	680	4.000	0.33
FPI0504-821 □	820	4.400	0.30
FPI0504-102 □	1000	5.000	0.28

UNSHIELDED SMD POWER INDUCTORS / FPI TYPE

ELECTRICAL CHARACTERISTICS FOR FPI0703

Part No.	Inductance (uH)	RDC (Ω)	IDC (A)
FPI0703-1R0 □	1.0	0.020	11.00
FPI0703-1R5 □	1.5	0.025	8.00
FPI0703-2R2 □	2.2	0.030	6.50
FPI0703-3R3 □	3.3	0.040	5.60
FPI0703-4R7 □	4.7	0.045	4.50
FPI0703-5R6 □	5.6	0.050	4.00
FPI0703-6R8 □	6.8	0.065	3.70
FPI0703-100 □	10	0.080	3.40
FPI0703-150 □	15	0.100	3.00
FPI0703-220 □	22	0.130	2.20
FPI0703-330 □	33	0.170	2.00
FPI0703-470 □	47	0.250	1.40
FPI0703-560 □	56	0.300	1.30
FPI0703-680 □	68	0.330	1.20
FPI0703-101 □	100	0.480	0.95
FPI0703-151 □	150	0.750	0.85
FPI0703-181 □	180	1.020	0.80
FPI0703-221 □	220	1.200	0.70
FPI0703-331 □	330	1.500	0.52
FPI0703-471 □	470	2.400	0.42
FPI0703-561 □	560	2.700	0.37
FPI0703-102 □	1000	4.000	0.29

UNSHIELDED SMD POWER INDUCTORS / FPI TYPE

ELECTRICAL CHARACTERISTICS FOR FPI0705

Part No.	Inductance (uH)	RDC (Ω)	IDC (A)
FPI0705-1R0 □	1.0	0.020	12.00
FPI0705-1R5 □	1.5	0.024	8.40
FPI0705-2R2 □	2.2	0.028	6.80
FPI0705-3R3 □	3.3	0.031	6.50
FPI0705-3R9 □	3.9	0.033	6.00
FPI0705-4R7 □	4.7	0.035	5.50
FPI0705-5R6 □	5.6	0.037	5.20
FPI0705-6R8 □	6.8	0.040	4.90
FPI0705-8R2 □	8.2	0.050	3.80
FPI0705-100 □	10	0.070	3.50
FPI0705-120 □	12	0.080	3.30
FPI0705-150 □	15	0.090	3.10
FPI0705-180 □	18	0.100	2.90
FPI0705-220 □	22	0.130	2.30
FPI0705-270 □	27	0.140	2.20
FPI0705-330 □	33	0.150	2.10
FPI0705-470 □	47	0.180	1.80
FPI0705-560 □	56	0.240	1.55
FPI0705-680 □	68	0.280	1.40
FPI0705-820 □	82	0.370	1.20
FPI0705-101 □	100	0.430	1.10
FPI0705-121 □	120	0.470	1.00
FPI0705-151 □	150	0.640	0.95
FPI0705-181 □	180	0.710	0.85
FPI0705-221 □	220	0.960	0.80
FPI0705-271 □	270	1.110	0.70
FPI0705-331 □	330	1.260	0.60
FPI0705-471 □	470	1.600	0.50
FPI0705-561 □	560	1.800	0.43
FPI0705-681 □	680	2.000	0.40
FPI0705-821 □	820	2.570	0.37
FPI0705-102 □	1000	4.000	0.35

UNSHIELDED SMD POWER INDUCTORS / FPI TYPE

ELECTRICAL CHARACTERISTICS FOR FPI0706

Part No.	Inductance (uH)	RDC (Ω)	IDC (A)
FPI0706-470 □	47	1.850	2.20
FPI0706-151 □	150	1.900	1.10
FPI0706-821 □	820	3.000	0.49
FPI0706-102 □	1000	3.900	0.45
FPI0706-152 □	1500	5.800	0.39

ELECTRICAL CHARACTERISTICS FOR FPI0707

Part No.	Inductance (uH)	RDC (Ω)	IDC (A)
FPI0707-330 □	33	0.140	3.00
FPI0707-470 □	47	0.170	2.50
FPI0707-151 □	150	0.600	1.30
FPI0707-221 □	220	0.800	1.10
FPI0707-801 □	800	2.600	0.54
FPI0707-102 □	1000	3.800	0.44
FPI0707-122 □	1200	4.300	0.40
FPI0707-152 □	1500	5.200	0.32

ELECTRICAL CHARACTERISTICS FOR FPI1004

Part No.	Inductance (uH)	RDC (Ω)	IDC (A)
FPI1004-1R2 □	1.2	0.022	9.00
FPI1004-6R8 □	6.8	0.040	5.00
FPI1004-100 □	10	0.065	3.80
FPI1004-150 □	15	0.080	3.20
FPI1004-180 □	18	0.090	3.10
FPI1004-220 □	22	0.110	3.00
FPI1004-270 □	27	0.120	2.50
FPI1004-330 □	33	0.140	2.10
FPI1004-390 □	39	0.150	2.00
FPI1004-470 □	47	0.170	1.80
FPI1004-680 □	68	0.260	1.50
FPI1004-101 □	100	0.320	1.40
FPI1004-221 □	220	0.770	0.80
FPI1004-331 □	330	1.150	0.95
FPI1004-471 □	470	1.600	0.55
FPI1004-561 □	560	1.700	0.50
FPI1004-102 □	1000	3.500	0.45

UNSHIELDED SMD POWER INDUCTORS / FPI TYPE

ELECTRICAL CHARACTERISTICS FOR FPI1005

Part No.	Inductance (μ H)	RDC (Ω)	IDC (A)
FPI1005-1R0 □	1.0	0.020	16.00
FPI1005-2R2 □	2.2	0.023	10.20
FPI1005-3R3 □	3.3	0.031	8.00
FPI1005-4R7 □	4.7	0.033	6.30
FPI1005-5R6 □	5.6	0.034	5.90
FPI1005-6R8 □	6.8	0.038	5.50
FPI1005-8R2 □	8.2	0.040	5.20
FPI1005-100 □	10	0.060	5.00
FPI1005-150 □	15	0.080	4.00
FPI1005-180 □	18	0.090	3.40
FPI1005-220 □	22	0.100	3.00
FPI1005-330 □	33	0.120	2.80
FPI1005-390 □	39	0.150	2.30
FPI1005-470 □	47	0.170	2.20
FPI1005-560 □	56	0.190	2.00
FPI1005-680 □	68	0.220	1.80
FPI1005-820 □	82	0.250	1.70
FPI1005-101 □	100	0.300	1.60
FPI1005-121 □	120	0.400	1.55
FPI1005-151 □	150	0.470	1.45
FPI1005-181 □	180	0.630	1.35
FPI1005-221 □	220	0.730	1.00
FPI1005-331 □	330	1.150	0.68
FPI1005-471 □	470	1.480	0.57
FPI1005-561 □	560	1.500	0.53
FPI1005-681 □	680	1.600	0.50
FPI1005-821 □	820	2.000	0.38
FPI1005-102 □	1000	3.800	0.20

UNSHIELDED SMD POWER INDUCTORS / FPI TYPE

ELECTRICAL CHARACTERISTICS FOR FPI1006

Part No.	Inductance (uH)	RDC (Ω)	IDC (A)
FPI1006-1R5 □	1.5	0.020	20.00
FPI1006-3R3 □	3.3	0.030	15.00
FPI1006-100 □	10	0.050	9.20
FPI1006-150 □	15	0.070	7.00
FPI1006-220 □	22	0.075	6.20
FPI1006-330 □	33	0.090	4.50
FPI1006-390 □	39	0.100	3.80
FPI1006-470 □	47	0.130	2.40
FPI1006-560 □	56	0.140	2.00
FPI1006-680 □	68	0.200	1.75
FPI1006-101 □	100	0.218	1.70
FPI1006-121 □	120	0.280	1.60
FPI1006-151 □	150	0.330	1.50
FPI1006-221 □	220	0.600	1.40
FPI1006-331 □	330	0.750	1.30
FPI1006-471 □	470	1.100	1.20
FPI1006-102 □	1000	3.500	0.45

ELECTRICAL CHARACTERISTICS FOR FPI1008

Part No.	Inductance (uH)	RDC (Ω)	IDC (A)
FPI1008-6R8 □	6.8	0.026	9.50
FPI1008-100 □	10	0.028	8.00
FPI1008-150 □	15	0.040	6.40
FPI1008-220 □	22	0.052	5.00
FPI1008-330 □	33	0.055	4.50
FPI1008-470 □	47	0.111	3.80
FPI1008-680 □	68	0.130	3.30
FPI1008-820 □	82	0.150	3.00
FPI1008-101 □	100	0.175	2.00
FPI1008-221 □	220	0.350	1.70
FPI1008-331 □	330	0.580	1.30
FPI1008-471 □	470	0.780	1.10
FPI1008-681 □	680	1.180	0.95
FPI1008-102 □	1000	1.650	0.60

UNSHIELDED SMD POWER INDUCTORS / FPI TYPE

ELECTRICAL CHARACTERISTICS FOR FPI1206

Part No.	Inductance (uH)	RDC (Ω)	IDC (A)
FPI1206-1R5 □	1.5	0.005	22.00
FPI1206-2R2 □	2.2	0.008	20.00
FPI1206-3R3 □	3.3	0.009	17.00
FPI1206-4R7 □	4.7	0.012	15.00
FPI1206-5R6 □	5.6	0.015	13.00
FPI1206-6R8 □	6.8	0.017	11.50
FPI1206-8R2 □	8.2	0.019	10.80
FPI1206-100 □	10	0.023	10.20
FPI1206-150 □	15	0.034	8.00
FPI1206-180 □	18	0.040	7.50
FPI1206-220 □	22	0.052	7.00
FPI1206-330 □	33	0.070	5.50
FPI1206-470 □	47	0.082	4.70
FPI1206-560 □	56	0.112	4.30
FPI1206-680 □	68	0.135	4.00
FPI1206-820 □	82	0.140	3.70
FPI1206-101 □	100	0.180	3.20
FPI1206-121 □	120	0.230	3.00
FPI1206-151 □	150	0.260	2.70
FPI1206-181 □	180	0.350	2.40
FPI1206-221 □	220	0.380	2.20
FPI1206-271 □	270	0.480	1.90
FPI1206-331 □	330	0.520	1.70
FPI1206-391 □	390	0.650	1.60
FPI1206-471 □	470	0.800	1.50
FPI1206-561 □	560	1.100	1.30
FPI1206-681 □	680	1.150	1.20
FPI1206-821 □	820	1.600	1.10
FPI1206-102 □	1000	1.700	1.00

* 100uH 以上 Test Frequency : 1KHZ/1V

* 100uH 以下 Test Frequency : 2.52MHZ/1V

CORE MASTER ENTERPRISE CO., LTD.

<http://www.coremaster.com.tw>



UNSHIELDED SMD POWER INDUCTORS / DS TYPE

FEATURES

- ◆ Designed for the smallest possible size and high performance
- ◆ They are with high energy storage and very low resistance making them the ideal inductors for DC-DC conversion in the following applications
- ◆ DS 1608 used ceramic base with gold-plating
- ◆ Others used LCP plastic base



APPLICATIONS

- ◆ Portable telephones.
- ◆ Personal computers.
- ◆ DC/DC converters, etc.
- ◆ Other various electronic appliances.

ORDERING CODE

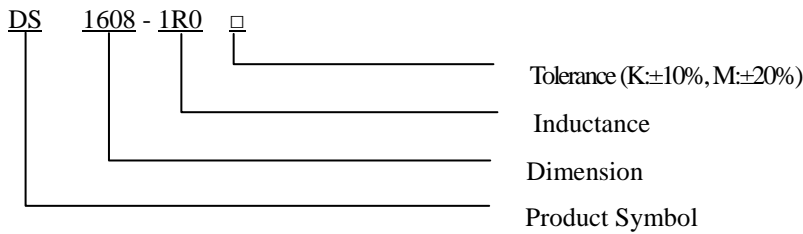

SHAPES

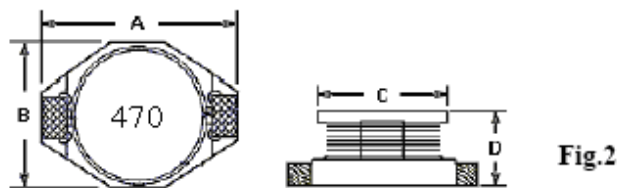
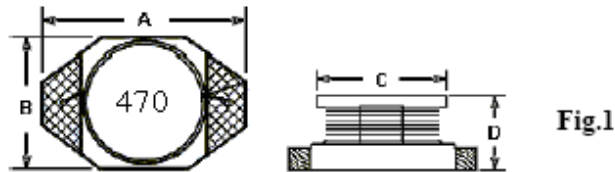

DIMENSIONS (UNIT: mm)

Part No.	Fig.	A(Max)	B(Max)	C(Max)	D(Max)
DS 1608	1	6.60	4.45	3.94	2.92
DS 3308	2	12.95	9.40	8.38	3.00
DS 3316	2	12.95	9.40	8.38	5.21
DS 3340	2	12.95	9.40	8.38	11.43
DS 5022	2	18.51	15.24	12.70	7.11

UNSHIELDED SMD POWER INDUCTORS / DS TYPE

ELECTRICAL CHARACTERISTICS FOR DS1608

Part No.	Inductance (uH)	RDC (Ω)	IDC (A)
DS1608-1R0 □	1.0	0.063	5.00
DS1608-2R2 □	2.2	0.070	3.90
DS1608-3R3 □	3.3	0.080	3.00
DS1608-4R7 □	4.7	0.100	2.50
DS1608-6R8 □	6.8	0.138	2.20
DS1608-8R2 □	8.2	0.149	2.00
DS1608-100 □	10	0.160	1.70
DS1608-150 □	15	0.230	1.40
DS1608-220 □	22	0.400	1.10
DS1608-270 □	27	0.420	1.05
DS1608-330 □	33	0.510	0.90
DS1608-470 □	47	0.750	0.70
DS1608-680 □	68	0.800	0.65
DS1608-101 □	100	1.270	0.55
DS1608-181 □	180	2.500	0.40
DS1608-221 □	220	3.100	0.30
DS1608-331 □	330	4.200	0.20
DS1608-471 □	470	9.580	0.15
DS1608-681 □	680	9.600	0.13
DS1608-102 □	1000	12.000	0.10

ELECTRICAL CHARACTERISTICS FOR DS3308

Part No.	Inductance (uH)	RDC (Ω)	IDC (A)
DS3308-4R7 □	4.7	0.060	4.40
DS3308-6R8 □	6.8	0.070	3.70
DS3308-100 □	10	0.080	2.65
DS3308-150 □	15	0.150	2.30
DS3308-220 □	22	0.180	2.00
DS3308-330 □	33	0.300	1.60
DS3308-470 □	47	0.400	1.42
DS3308-680 □	68	0.660	1.10
DS3308-101 □	100	0.840	0.90
DS3308-151 □	150	1.200	0.83
DS3308-221 □	220	1.900	0.65
DS3308-681 □	680	3.050	0.30
DS3308-102 □	1000	5.200	0.20

CORE MASTER ENTERPRISE CO., LTD.



<http://www.coremaster.com.tw>

UNSHIELDED SMD POWER INDUCTORS / DS TYPE

ELECTRICAL CHARACTERISTICS FOR DS3316

Part No.	Inductance (uH)	RDC (Ω)	IDC (A)
DS3316-1R0 □	1.0	0.007	15.00
DS3316-2R2 □	2.2	0.020	12.10
DS3316-3R3 □	3.3	0.021	9.00
DS3316-4R7 □	4.7	0.023	8.00
DS3316-6R8 □	6.8	0.045	6.40
DS3316-100 □	10	0.050	5.60
DS3316-150 □	15	0.065	5.00
DS3316-180 □	18	0.070	4.00
DS3316-220 □	22	0.085	3.60
DS3316-330 □	33	0.100	3.20
DS3316-470 □	47	0.140	2.30
DS3316-680 □	68	0.200	2.00
DS3316-101 □	100	0.280	1.50
DS3316-151 □	150	0.400	1.40
DS3316-221 □	220	0.610	1.00
DS3316-331 □	330	1.020	0.95
DS3316-471 □	470	1.400	0.50
DS3316-681 □	680	2.000	0.40
DS3316-102 □	1000	3.500	0.30

ELECTRICAL CHARACTERISTICS FOR DS3340

Part No.	Inductance (uH)	RDC (Ω)	IDC (A)
DS3340-1R0 □	1.0	0.007	20.00
DS3340-2R2 □	2.2	0.016	19.50
DS3340-3R3 □	3.3	0.018	19.00
DS3340-4R7 □	4.7	0.020	18.00
DS3340-6R8 □	6.8	0.040	11.00
DS3340-100 □	10	0.045	10.50
DS3340-150 □	15	0.055	10.00
DS3340-220 □	22	0.070	8.50
DS3340-330 □	33	0.080	7.30
DS3340-470 □	47	0.100	6.00
DS3340-680 □	68	0.170	4.80
DS3340-101 □	100	0.220	3.20
DS3340-151 □	150	0.340	3.00
DS3340-221 □	220	0.440	2.60

CORE MASTER ENTERPRISE CO., LTD.

<http://www.coremaster.com.tw>



UNSHIELDED SMD POWER INDUCTORS / DS TYPE

ELECTRICAL CHARACTERISTICS FOR DS3340

Part No.	Inductance (uH)	RDC (Ω)	IDC (A)
DS3340-331 □	330	0.700	2.00
DS3340-471 □	470	0.950	1.20
DS3340-681 □	680	1.000	1.10
DS3340-821 □	820	1.630	1.00
DS3340-102 □	1000	2.600	0.50

ELECTRICAL CHARACTERISTICS FOR DS5022

Part No.	Inductance (uH)	RDC (Ω)	IDC (A)
DS5022-1R0 □	1.0	0.008	20.00
DS5022-2R2 □	2.2	0.020	19.00
DS5022-3R3 □	3.3	0.025	18.00
DS5022-5R6 □	5.6	0.030	16.00
DS5022-100 □	10	0.032	14.50
DS5022-150 □	15	0.036	12.00
DS5022-220 □	22	0.047	10.00
DS5022-330 □	33	0.070	9.00
DS5022-470 □	47	0.077	7.00
DS5022-680 □	68	0.120	6.00
DS5022-101 □	100	0.190	5.00
DS5022-151 □	150	0.250	4.00
DS5022-221 □	220	0.380	3.00
DS5022-331 □	330	0.560	2.50
DS5022-471 □	470	0.850	2.20
DS5022-681 □	680	0.910	1.60
DS5022-102 □	1000	2.500	1.00
DS5022-222 □	2200	3.300	0.40

* 100uH 以上 Test Frequency : 1KHZ/1V

* 100uH 以下 Test Frequency : 100KHZ/0.1V

CORE MASTER ENTERPRISE CO., LTD.

<http://www.coremaster.com.tw>



SHIELDED SMD POWER INDUCTORS / SRI TYPE

FEATURES

- ◆ Excellent solder ability and high heat resistance for flow soldering.
- ◆ For large current circuits due to its low DC resistance.
- ◆ Excellent in terminal strength due to its high performance ferrite core material and solder ability.



APPLICATIONS

- ◆ Power supply for VTRs.
- ◆ Portable communication equipment.
- ◆ Notebook PCs.
- ◆ LCD televisions.
- ◆ DC/DC converters, etc.

ORDERING CODE

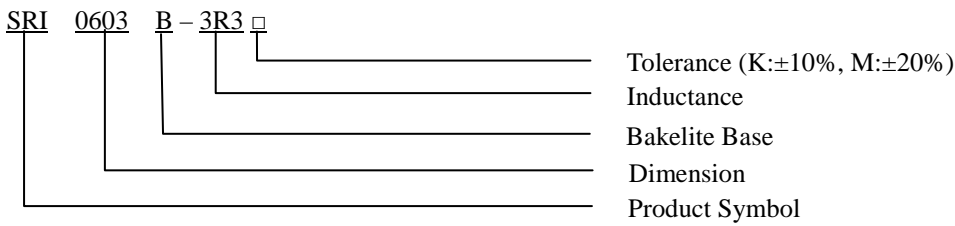

SHAPES

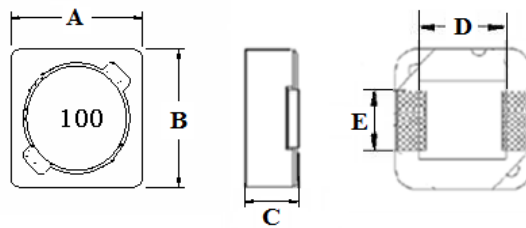

Fig.1

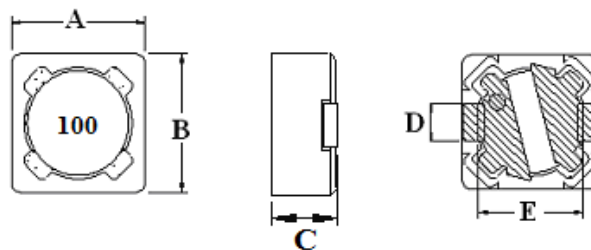

Fig.2

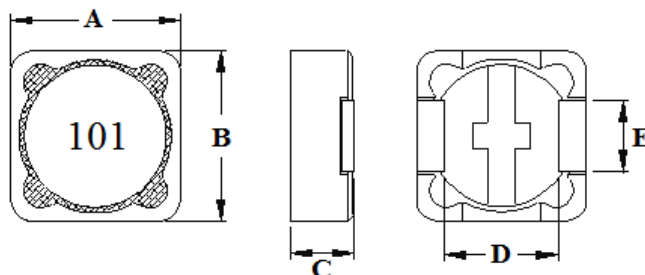

Fig.3

CORE MASTER ENTERPRISE CO., LTD.

<http://www.coremaster.com.tw>



SHIELDED SMD POWER INDUCTORS / SRI TYPE

DIMENSIONS (UNIT: mm)

Part No.	Fig.	A	B	C (Max)	D (Ref.)	E (Ref.)
SRI 0603 B	1	6.6 ± 0.3	6.2 ± 0.3	3.0	4.0	1.50
SRI 0605 B	1	6.6 ± 0.3	6.2 ± 0.3	5.0	4.0	1.50
SRI 0703	2	7.3 ± 0.3	7.3 ± 0.3	3.4	2.0	5.00
SRI 0704	2	7.3 ± 0.3	7.3 ± 0.3	4.5	2.0	5.00
SRI 1004	3	10.0 ± 0.5	10.0 ± 0.5	4.5	6.1	3.86
SRI 1204	3	12.0 ± 0.5	12.0 ± 0.5	5.0	8.0	5.00
SRI 1205	3	12.0 ± 0.5	12.0 ± 0.5	6.0	8.0	5.00
SRI 1207	3	12.0 ± 0.5	12.0 ± 0.5	8.0	8.0	5.00
SRI 1209	3	12.0 ± 0.5	12.0 ± 0.5	10.0	8.0	5.00

ELECTRICAL CHARACTERISTICS FOR SRI0603B

Part No.	Inductance (μH)	RDC (Ω)	IDC (A)
SRI0603B-1R0 □	1.0	0.030	5.50
SRI0603B-1R5 □	1.5	0.040	4.50
SRI0603B-2R2 □	2.2	0.050	3.50
SRI0603B-3R3 □	3.3	0.055	3.00
SRI0603B-4R7 □	4.7	0.060	2.40
SRI0603B-5R6 □	5.6	0.072	2.30
SRI0603B-6R8 □	6.8	0.095	2.20
SRI0603B-100 □	10	0.150	1.90
SRI0603B-220 □	22	0.340	1.20
SRI0603B-330 □	33	0.450	1.00
SRI0603B-470 □	47	0.690	0.85
SRI0603B-680 □	68	0.750	0.65
SRI0603B-820 □	82	0.770	0.55
SRI0603B-101 □	100	1.400	0.50
SRI0603B-121 □	120	1.900	0.45
SRI0603B-181 □	180	2.770	0.40
SRI0603B-471 □	470	4.030	0.26
SRI0603B-681 □	680	6.300	0.21
SRI0603B-821 □	820	7.400	0.20
SRI0603B-102 □	1000	10.500	0.16

CORE MASTER ENTERPRISE CO., LTD.



<http://www.coremaster.com.tw>

SHIELDED SMD POWER INDUCTORS / SRI TYPE

ELECTRICAL CHARACTERISTICS FOR SRI0605B

Part No.	Inductance (uH)	RDC (Ω)	IDC (A)
SRI0605B-1R5 □	1.5	0.030	6.30
SRI0605B-2R2 □	2.2	0.048	4.30
SRI0605B-6R8 □	6.8	0.080	2.90
SRI0605B-100 □	10	0.120	2.00
SRI0605B-150 □	15	0.180	1.90
SRI0605B-220 □	22	0.270	1.70
SRI0605B-270 □	27	0.350	1.50
SRI0605B-330 □	33	0.450	1.40
SRI0605B-470 □	47	0.520	1.10
SRI0605B-680 □	68	0.630	0.95
SRI0605B-101 □	100	1.030	0.80
SRI0605B-151 □	150	1.100	0.60
SRI0605B-471 □	470	3.000	0.35
SRI0605B-561 □	560	4.000	0.30
SRI0605B-102 □	1000	8.000	0.20

SHIELDED SMD POWER INDUCTORS / SRI TYPE

ELECTRICAL CHARACTERISTICS FOR SRI0703

Part No.	Inductance (uH)	RDC (Ω)	IDC (A)
SRI0703-1R0 □	1.0	0.020	7.00
SRI0703-1R5 □	1.5	0.028	6.00
SRI0703-2R2 □	2.2	0.032	4.50
SRI0703-3R3 □	3.3	0.040	4.20
SRI0703-4R7 □	4.7	0.055	3.35
SRI0703-6R8 □	6.8	0.065	3.00
SRI0703-100 □	10	0.076	2.30
SRI0703-120 □	12	0.100	2.20
SRI0703-150 □	15	0.130	2.00
SRI0703-180 □	18	0.150	1.80
SRI0703-220 □	22	0.190	1.50
SRI0703-330 □	33	0.280	1.20
SRI0703-390 □	39	0.340	0.90
SRI0703-470 □	47	0.450	0.80
SRI0703-560 □	56	0.500	0.70
SRI0703-680 □	68	0.520	0.61
SRI0703-820 □	82	0.690	0.55
SRI0703-101 □	100	0.790	0.50
SRI0703-151 □	150	1.000	0.46
SRI0703-181 □	180	1.100	0.39
SRI0703-221 □	220	1.650	0.38
SRI0703-271 □	270	2.310	0.36
SRI0703-331 □	330	2.620	0.35
SRI0703-471 □	470	4.180	0.32
SRI0703-681 □	680	5.730	0.30
SRI0703-821 □	820	7.000	0.27
SRI0703-102 □	1000	9.660	0.23

SHIELDED SMD POWER INDUCTORS / SRI TYPE

ELECTRICAL CHARACTERISTICS FOR SRI0704

Part No.	Inductance (uH)	RDC (Ω)	IDC (A)
SRI0704-1R0 □	1.0	0.015	9.00
SRI0704-1R5 □	1.5	0.026	8.00
SRI0704-2R2 □	2.2	0.030	6.20
SRI0704-2R7 □	2.7	0.035	5.50
SRI0704-3R3 □	3.3	0.038	4.70
SRI0704-4R7 □	4.7	0.047	3.50
SRI0704-6R8 □	6.8	0.050	3.40
SRI0704-7R7 □	7.7	0.053	3.10
SRI0704-100 □	10	0.055	3.00
SRI0704-150 □	15	0.081	2.50
SRI0704-180 □	18	0.100	2.00
SRI0704-220 □	22	0.110	1.95
SRI0704-270 □	27	0.128	1.50
SRI0704-330 □	33	0.250	1.20
SRI0704-390 □	39	0.300	1.10
SRI0704-470 □	47	0.320	1.00
SRI0704-560 □	56	0.350	0.95
SRI0704-680 □	68	0.380	0.90
SRI0704-101 □	100	0.610	0.85
SRI0704-121 □	120	0.850	0.80
SRI0704-151 □	150	0.880	0.75
SRI0704-181 □	180	1.350	0.70
SRI0704-221 □	220	1.400	0.62
SRI0704-271 □	270	1.500	0.55
SRI0704-331 □	330	1.500	0.50
SRI0704-391 □	390	1.800	0.48
SRI0704-471 □	470	2.600	0.44
SRI0704-561 □	560	2.700	0.40
SRI0704-681 □	680	3.700	0.38
SRI0704-821 □	820	4.500	0.32
SRI0704-102 □	1000	5.000	0.22

CORE MASTER ENTERPRISE CO., LTD.



<http://www.coremaster.com.tw>

SHIELDED SMD POWER INDUCTORS / SRI TYPE

ELECTRICAL CHARACTERISTICS FOR SRI1004

Part No.	Inductance (uH)	RDC (Ω)	IDC (A)
SRI1004-1R2 □	1.2	0.015	13.00
SRI1004-2R2 □	2.2	0.020	9.00
SRI1004-3R3 □	3.3	0.025	8.00
SRI1004-4R7 □	4.7	0.030	6.00
SRI1004-5R6 □	5.6	0.035	5.80
SRI1004-6R8 □	6.8	0.040	5.60
SRI1004-8R2 □	8.2	0.045	5.00
SRI1004-100 □	10	0.050	4.50
SRI1004-150 □	15	0.080	3.90
SRI1004-220 □	22	0.100	3.30
SRI1004-330 □	33	0.200	2.60
SRI1004-470 □	47	0.230	2.00
SRI1004-680 □	68	0.300	1.70
SRI1004-820 □	82	0.350	1.65
SRI1004-101 □	100	0.400	1.53
SRI1004-121 □	120	0.500	1.40
SRI1004-221 □	220	0.600	1.05
SRI1004-331 □	330	0.900	0.83
SRI1004-471 □	470	1.230	0.90
SRI1004-681 □	680	2.000	0.58
SRI1004-821 □	820	3.000	0.55
SRI1004-102 □	1000	3.200	0.50

SHIELDED SMD POWER INDUCTORS / SRI TYPE

ELECTRICAL CHARACTERISTICS FOR SRI1204

Part No.	Inductance (uH)	RDC (Ω)	IDC (A)
SRI1204-2R2 □	2.2	0.012	9.80
SRI1204-3R0 □	3.0	0.015	9.20
SRI1204-3R9 □	3.9	0.020	8.00
SRI1204-4R7 □	4.7	0.025	7.80
SRI1204-5R6 □	5.6	0.030	7.30
SRI1204-6R8 □	6.8	0.031	6.30
SRI1204-8R2 □	8.2	0.033	5.00
SRI1204-100 □	10	0.035	4.50
SRI1204-120 □	12	0.038	4.20
SRI1204-150 □	15	0.050	4.00
SRI1204-180 □	18	0.057	3.70
SRI1204-220 □	22	0.060	3.50
SRI1204-270 □	27	0.080	3.00
SRI1204-330 □	33	0.097	2.70
SRI1204-470 □	47	0.150	2.10
SRI1204-560 □	56	0.190	1.95
SRI1204-680 □	68	0.220	1.75
SRI1204-820 □	82	0.260	1.70
SRI1204-101 □	100	0.280	1.55
SRI1204-121 □	120	0.290	1.45
SRI1204-151 □	150	0.530	1.30
SRI1204-221 □	220	0.700	1.05
SRI1204-271 □	270	0.800	0.95

SHIELDED SMD POWER INDUCTORS / SRI TYPE

ELECTRICAL CHARACTERISTICS FOR SRI1205

Part No.	Inductance (uH)	RDC (Ω)	IDC (A)
SRI1205-1R0 □	1.0	0.017	16.00
SRI1205-1R5 □	1.5	0.018	12.00
SRI1205-2R2 □	2.2	0.020	10.00
SRI1205-3R3 □	3.3	0.021	8.50
SRI1205-4R7 □	4.7	0.022	8.00
SRI1205-5R6 □	5.6	0.023	7.50
SRI1205-6R8 □	6.8	0.024	6.50
SRI1205-8R2 □	8.2	0.025	6.00
SRI1205-100 □	10	0.026	5.00
SRI1205-150 □	15	0.030	4.20
SRI1205-180 □	18	0.034	4.00
SRI1205-220 □	22	0.045	3.50
SRI1205-270 □	27	0.055	3.10
SRI1205-330 □	33	0.067	2.90
SRI1205-390 □	39	0.083	2.80
SRI1205-470 □	47	0.110	2.50
SRI1205-560 □	56	0.140	2.00
SRI1205-680 □	68	0.160	1.80
SRI1205-820 □	82	0.180	1.70
SRI1205-101 □	100	0.240	1.60
SRI1205-121 □	120	0.290	1.50
SRI1205-151 □	150	0.320	1.40
SRI1205-181 □	180	0.340	1.20
SRI1205-221 □	220	0.550	1.10
SRI1205-271 □	270	0.580	1.00
SRI1205-331 □	330	0.620	0.90
SRI1205-391 □	390	0.640	0.80
SRI1205-471 □	470	0.820	0.70
SRI1205-561 □	560	0.840	0.65
SRI1205-681 □	680	1.200	0.60
SRI1205-821 □	820	1.340	0.50
SRI1205-102 □	1000	1.650	0.43

CORE MASTER ENTERPRISE CO., LTD.



<http://www.coremaster.com.tw>

SHIELDED SMD POWER INDUCTORS / SRI TYPE

ELECTRICAL CHARACTERISTICS FOR SRI1207

Part No.	Inductance (uH)	RDC (Ω)	IDC (A)
SRI1207-1R2 □	1.2	0.015	19.00
SRI1207-2R2 □	2.2	0.016	18.00
SRI1207-3R3 □	3.3	0.018	13.00
SRI1207-4R7 □	4.7	0.019	12.00
SRI1207-5R6 □	5.6	0.020	11.50
SRI1207-6R8 □	6.8	0.022	11.00
SRI1207-8R2 □	8.2	0.023	9.50
SRI1207-100 □	10	0.024	8.00
SRI1207-120 □	12	0.025	7.50
SRI1207-150 □	15	0.027	7.00
SRI1207-180 □	18	0.033	6.00
SRI1207-220 □	22	0.043	5.50
SRI1207-270 □	27	0.046	5.20
SRI1207-330 □	33	0.065	3.50
SRI1207-390 □	39	0.073	3.40
SRI1207-470 □	47	0.100	3.30
SRI1207-560 □	56	0.120	3.20
SRI1207-680 □	68	0.130	3.10
SRI1207-820 □	82	0.150	3.00
SRI1207-101 □	100	0.220	2.90
SRI1207-121 □	120	0.290	2.25
SRI1207-151 □	150	0.300	2.10
SRI1207-181 □	180	0.320	2.00
SRI1207-221 □	220	0.430	1.70
SRI1207-271 □	270	0.500	1.60
SRI1207-331 □	330	0.550	1.50
SRI1207-391 □	390	0.580	1.40
SRI1207-471 □	470	0.650	1.30
SRI1207-561 □	560	0.720	1.10
SRI1207-681 □	680	0.800	1.00
SRI1207-821 □	820	1.000	0.90
SRI1207-102 □	1000	1.500	0.80

CORE MASTER ENTERPRISE CO., LTD.



<http://www.coremaster.com.tw>

SHIELDED SMD POWER INDUCTORS / SRI TYPE

ELECTRICAL CHARACTERISTICS FOR SRI1209

Part No.	Inductance (uH)	RDC (Ω)	IDC (A)
SRI1209-1R0 □	1.0	0.012	20.00
SRI1209-2R2 □	2.2	0.015	18.00
SRI1209-3R3 □	3.3	0.018	16.00
SRI1209-4R7 □	4.7	0.019	15.00
SRI1209-6R8 □	6.8	0.021	12.80
SRI1209-8R2 □	8.2	0.022	11.10
SRI1209-100 □	10	0.024	10.50
SRI1209-120 □	12	0.026	9.50
SRI1209-150 □	15	0.029	7.00
SRI1209-220 □	22	0.040	6.50
SRI1209-330 □	33	0.055	6.00
SRI1209-470 □	47	0.060	5.00
SRI1209-680 □	68	0.100	3.80
SRI1209-820 □	82	0.120	3.50
SRI1209-101 □	100	0.135	3.00
SRI1209-151 □	150	0.180	2.50
SRI1209-181 □	180	0.250	2.35
SRI1209-221 □	220	0.300	2.20
SRI1209-331 □	330	0.350	1.90
SRI1209-471 □	470	0.490	1.50
SRI1209-681 □	680	0.655	1.30
SRI1209-821 □	820	0.700	1.20
SRI1209-102 □	1000	0.830	1.00

*100uH 以上 Test Frequency : 1KHZ/1V

*100uH 以下 Test Frequency : 100KHZ/0.1V

CORE MASTER ENTERPRISE CO., LTD.



<http://www.coremaster.com.tw>

SHIELDED SMD POWER INDUCTORS / SPI TYPE

FEATURES

- ◆ With magnetic shield against radiation
- ◆ With magnetic shield against radiation
- ◆ Compact, low profile with low RDC and large current



APPLICATIONS

- ◆ Portable telephones.
- ◆ Personal computers.
- ◆ DC/DC converters, etc.
- ◆ Other various electronic appliances.

ORDERING CODE

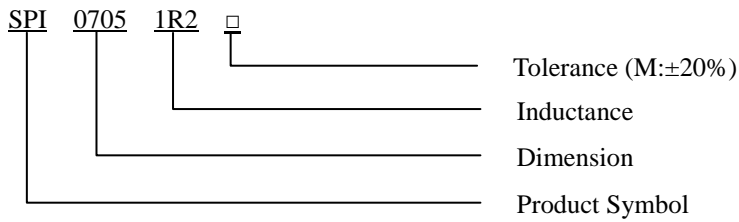

SHAPES

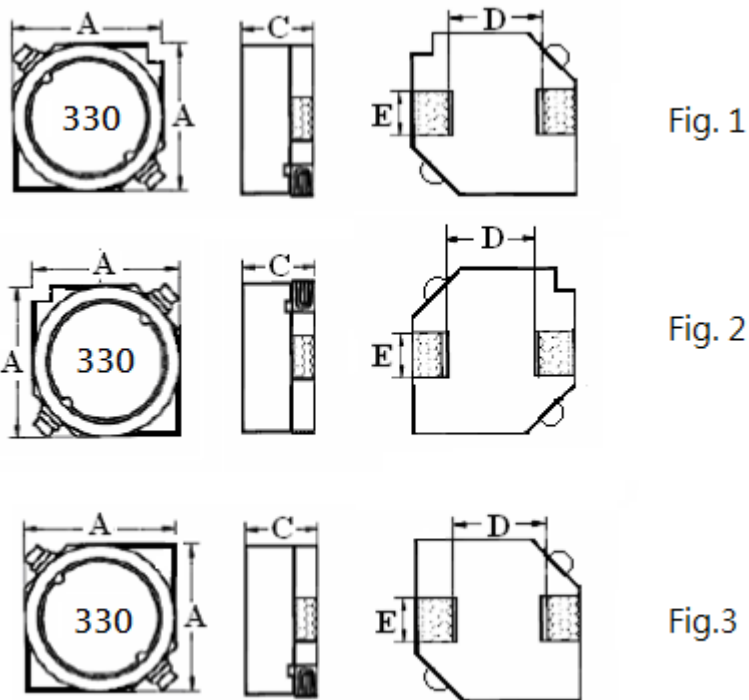

CORE MASTER ENTERPRISE CO., LTD.

<http://www.coremaster.com.tw>

SHIELDED SMD POWER INDUCTORS / SPI TYPE

DIMENSIONS (UNIT: mm)

Part No.	Fig.	A	C	D (Ref.)	E (Ref.)
SPI 0603	3	6.0 ± 0.2	2.8 ± 0.2	4.0	2.0
SPI 0703	1	7.0 ± 0.2	3.2 ± 0.2	4.9	2.0
SPI 0705	1	7.0 ± 0.2	4.5 ± 0.3	4.9	2.0
SPI 1005	1	10.5 ± 0.5	5.0 (MAX)	6.0	2.0
SPI 1207	2	12.5 ± 0.3	6.5 ± 0.35	8.6	2.0
SPI 1208	2	12.5 ± 0.3	7.5 ± 0.35	8.6	2.0

ELECTRICAL CHARACTERISTICS FOR SPI0603

Part No.	Inductance (μ H)	RDC (Ω)	IDC (A)
SPI0603-2R7 □	2.7	0.040	2.50
SPI0603-3R3 □	3.3	0.050	2.35
SPI0603-4R7 □	4.7	0.055	1.90
SPI0603-6R8 □	6.8	0.090	1.78
SPI0603-100 □	10	0.150	1.40
SPI0603-150 □	15	0.170	1.35
SPI0603-180 □	18	0.200	1.10
SPI0603-220 □	22	0.250	0.95
SPI0603-330 □	33	0.300	0.80
SPI0603-470 □	47	0.450	0.70
SPI0603-680 □	68	0.500	0.60
SPI0603-101 □	100	1.100	0.40
SPI0603-151 □	150	1.500	0.33



CORE MASTER ENTERPRISE CO., LTD.

<http://www.coremaster.com.tw>

SHIELDED SMD POWER INDUCTORS / SPI TYPE

ELECTRICAL CHARACTERISTICS FOR SPI0703

Part No.	Inductance (μ H)	RDC (Ω)	IDC (A)
SPI0703-1R0 □	1.0	0.025	7.00
SPI0703-2R2 □	2.2	0.030	4.50
SPI0703-3R3 □	3.3	0.035	3.20
SPI0703-4R7 □	4.7	0.040	2.80
SPI0703-6R8 □	6.8	0.060	2.30
SPI0703-100 □	10	0.080	1.90
SPI0703-150 □	15	0.095	1.45
SPI0703-220 □	22	0.170	1.30
SPI0703-330 □	33	0.160	1.10
SPI0703-470 □	47	0.268	0.96
SPI0703-680 □	68	0.350	0.80
SPI0703-101 □	100	0.450	0.60
SPI0703-151 □	150	1.000	0.50
SPI0703-221 □	220	1.500	0.35
SPI0703-102 □	1000	4.200	0.20

ELECTRICAL CHARACTERISTICS FOR SPI0705

Part No.	Inductance (μ H)	RDC (Ω)	IDC (A)
SPI0705-1R0 □	1.0	0.023	7.00
SPI0705-2R2 □	2.2	0.025	4.00
SPI0705-3R3 □	3.3	0.026	3.20
SPI0705-4R7 □	4.7	0.030	2.80
SPI0705-6R8 □	6.8	0.036	2.30
SPI0705-100 □	10	0.043	1.90
SPI0705-150 □	15	0.055	1.50
SPI0705-220 □	22	0.100	1.30
SPI0705-330 □	33	0.150	1.28
SPI0705-470 □	47	0.160	0.92
SPI0705-680 □	68	0.200	0.75
SPI0705-820 □	82	0.270	0.70
SPI0705-101 □	100	0.320	0.58



CORE MASTER ENTERPRISE CO., LTD.

<http://www.coremaster.com.tw>

SHIELDED SMD POWER INDUCTORS / SPI TYPE

ELECTRICAL CHARACTERISTICS FOR SPI0705

Part No.	Inductance (μ H)	RDC (Ω)	IDC (A)
SPI0705-121 □	120	0.350	0.53
SPI0705-221 □	220	0.800	0.40
SPI0705-331 □	330	0.850	0.36
SPI0705-102 □	1000	3.000	0.17

ELECTRICAL CHARACTERISTICS FOR SPI1005

Part No.	Inductance (μ H)	RDC (Ω)	IDC (A)
SPI1005-2R2 □	2.2	0.016	7.00
SPI1005-3R3 □	3.3	0.018	5.50
SPI1005-4R7 □	4.7	0.020	4.80
SPI1005-5R6 □	5.6	0.030	4.50
SPI1005-6R8 □	6.8	0.035	4.30
SPI1005-100 □	10	0.040	3.50
SPI1005-150 □	15	0.050	3.20
SPI1005-220 □	22	0.059	2.50
SPI1005-330 □	33	0.082	1.70
SPI1005-470 □	47	0.150	1.60
SPI1005-680 □	68	0.200	1.20
SPI1005-101 □	100	0.300	1.10
SPI1005-151 □	150	0.400	1.00
SPI1005-221 □	220	0.600	0.90
SPI1005-331 □	330	0.785	0.70
SPI1005-681 □	680	2.500	0.40



CORE MASTER ENTERPRISE CO., LTD.

<http://www.coremaster.com.tw>

SHIELDED SMD POWER INDUCTORS / SPI TYPE

ELECTRICAL CHARACTERISTICS FOR SPI1207

Part No.	Inductance (μ H)	RDC (Ω)	IDC (A)
SPI1207-6R8 □	6.8	0.028	6.20
SPI1207-100 □	10	0.030	5.80
SPI1207-220 □	22	0.070	5.00
SPI1207-330 □	33	0.080	4.50
SPI1207-470 □	47	0.130	3.60
SPI1207-680 □	68	0.185	3.00
SPI1207-681 □	680	0.980	0.70

ELECTRICAL CHARACTERISTICS FOR SPI1208

Part No.	Inductance (μ H)	RDC (Ω)	IDC (A)
SPI1208-150 □	15	0.055	7.0
SPI1208-220 □	22	0.070	5.7
SPI1208-470 □	47	0.125	3.0
SPI1208-101 □	100	0.230	2.7
SPI1208-151 □	150	0.250	1.5

* 100 μ H 以上 Test Frequency : 1KHZ/1V

* 100 μ H 以下 Test Frequency : 1KHZ/0.25V



CORE MASTER ENTERPRISE CO., LTD.

<http://www.coremaster.com.tw>

SHIELDED SMD POWER INDUCTORS / SDS TYPE

FEATURES

- ◆ With magnetic shield against radiation
- ◆ SDS 1608 used ceramic base with gold-plating
- ◆ Other used LCP plastic base



APPLICATIONS

- ◆ Portable telephones.
- ◆ Personal computers.
- ◆ DC/DC converters, etc.
- ◆ Other various electronic appliances.

ORDERING CODE

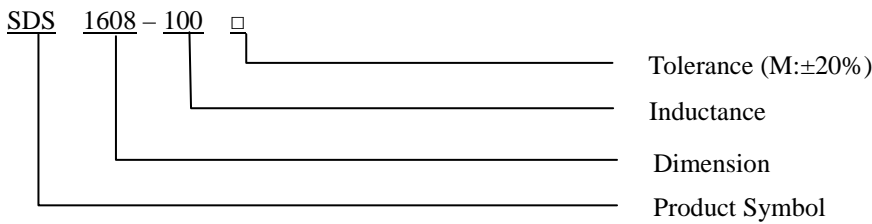

SHAPES

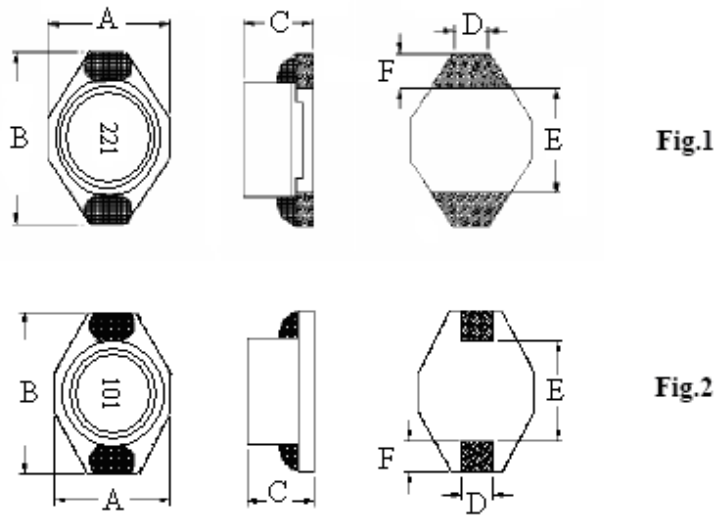

DIMENSIONS (UNIT: mm)

Part No.	Fig.	A(Max)	B(Max)	C(Max)	D(Ref)	E(Ref)	F(Ref)
SDS 1608	1	4.45	6.50	2.92	1.27	4.32	1.02
SDS 3316	2	9.40	12.95	5.21	2.54	7.62	2.54
SDS 5022	2	15.24	18.54	7.11	2.54	12.7	2.54

CORE MASTER ENTERPRISE CO., LTD.



<http://www.coremaster.com.tw>

SHIELDED SMD POWER INDUCTORS / SDS TYPE

ELECTRICAL CHARACTERISTICS FOR SDS1608

Part No.	Inductance (uH)	RDC (Ω)	IDC (A)
SDS1608-1R0 □	1.0	0.040	1.80
SDS1608-1R5 □	1.5	0.045	1.70
SDS1608-2R2 □	2.2	0.050	1.20
SDS1608-3R3 □	3.3	0.055	0.90
SDS1608-4R7 □	4.7	0.060	0.70
SDS1608-6R8 □	6.8	0.070	0.60
SDS1608-100 □	10	0.075	0.45
SDS1608-150 □	15	0.090	0.40
SDS1608-220 □	22	0.120	0.38
SDS1608-270 □	27	0.170	0.30
SDS1608-330 □	33	0.190	0.20
SDS1608-470 □	47	0.230	0.18
SDS1608-680 □	68	0.350	0.16
SDS1608-101 □	100	0.430	0.15
SDS1608-151 □	150	0.590	0.13
SDS1608-221 □	220	1.200	0.11
SDS1608-331 □	330	1.400	0.10
SDS1608-391 □	390	2.000	0.09
SDS1608-471 □	470	2.500	0.08

ELECTRICAL CHARACTERISTICS FOR SDS3316

Part No.	Inductance (uH)	RDC (Ω)	IDC (A)
SDS3316-1R0 □	1.0	0.021	16.00
SDS3316-2R2 □	2.2	0.030	10.50
SDS3316-100 □	10	0.145	5.00
SDS3316-220 □	22	0.200	3.40
SDS3316-330 □	33	0.400	2.60
SDS3316-101 □	100	1.110	1.45
SDS3316-151 □	150	1.550	1.25
SDS3316-221 □	220	2.000	1.00
SDS3316-681 □	680	5.010	0.23

CORE MASTER ENTERPRISE CO., LTD.



<http://www.coremaster.com.tw>

SHIELDED SMD POWER INDUCTORS / SDS TYPE

ELECTRICAL CHARACTERISTICS FOR SDS5022

Part No.	Inductance (uH)	RDC (Ω)	IDC (A)
SDS5022-4R7 □	4.7	0.025	12.00
SDS5022-8R2 □	8.2	0.035	9.60
SDS5022-100 □	10	0.040	8.30
SDS5022-150 □	15	0.048	7.50
SDS5022-220 □	22	0.070	5.80
SDS5022-330 □	33	0.085	5.00
SDS5022-470 □	47	0.100	4.00
SDS5022-680 □	68	0.180	3.50
SDS5022-101 □	100	0.200	3.00
SDS5022-151 □	150	0.293	2.00
SDS5022-221 □	220	0.470	1.90
SDS5022-331 □	330	0.780	1.50
SDS5022-471 □	470	1.200	1.30
SDS5022-102 □	1000	1.900	0.87

* 100uH 以上 Test Frequency : 1KHZ/1V

* 100uH 以下 Test Frequency : 100KHZ/0.1V

SHIELDED SMD POWER INDUCTORS / SDI TYPE

FEATURES

- ◆ Ideal inductors for DC-DC conversion
- ◆ With magnetic shield against radiation
- ◆ High power and high saturation inductors
- ◆ Directly connected electrode on ferrite core



APPLICATIONS

- ◆ Power supply for VTRs .
- ◆ Portable communication equipment .
- ◆ Notebook PCs .
- ◆ LCD televisions .
- ◆ DC/DC converters,etc.

ORDERING CODE

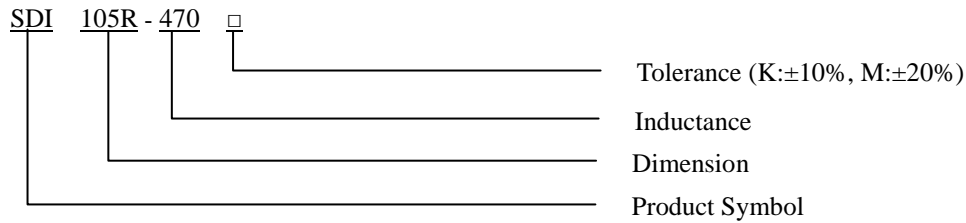

SHAPES

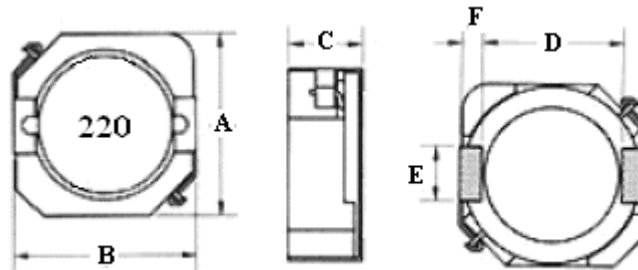

DIMENSIONS (UNIT: mm)

Part No.	A(Max)	B(Max)	C(Max)	D(Ref.)	E(Ref.)	F(Ref.)
SDI 103R	10.3	10.5	3	7.7	3	1.2
SDI 104R	10.3	10.5	4	7.7	3	1.2
SDI 105R	10.3	10.5	5	7.7	3	1.2

SHIELDED SMD POWER INDUCTORS / SDI TYPE

ELECTRICAL CHARACTERISTICS FOR SDI103R

Part No.	Inductance (uH)	RDC (Ω)	IDC (A)
SDI103R-1R5 □	1.5	0.020	5.00
SDI103R-3R3 □	3.3	0.027	4.20
SDI103R-4R7 □	4.7	0.028	3.50
SDI103R-8R2 □	8.2	0.045	3.30
SDI103R-100 □	10	0.050	2.40
SDI103R-150 □	15	0.080	2.30
SDI103R-220 □	22	0.100	2.16
SDI103R-330 □	33	0.135	1.74
SDI103R-470 □	47	0.230	1.40
SDI103R-560 □	56	0.240	1.20
SDI103R-680 □	68	0.278	1.10
SDI103R-101 □	100	0.360	0.80
SDI103R-221 □	220	1.000	0.65

ELECTRICAL CHARACTERISTICS FOR SDI104R

Part No.	Inductance (uH)	RDC (Ω)	IDC (A)
SDI104R-1R0 □	1.0	0.018	8.00
SDI104R-2R2 □	2.2	0.020	6.80
SDI104R-3R3 □	3.3	0.022	6.20
SDI104R-4R7 □	4.7	0.024	5.00
SDI104R-5R6 □	5.6	0.025	4.80
SDI104R-6R8 □	6.8	0.027	4.50
SDI104R-8R2 □	8.2	0.033	4.00
SDI104R-100 □	10	0.040	3.50
SDI104R-150 □	15	0.050	3.00
SDI104R-180 □	18	0.055	2.95
SDI104R-220 □	22	0.073	2.90
SDI104R-270 □	27	0.090	2.50
SDI104R-330 □	33	0.093	2.00
SDI104R-470 □	47	0.128	1.80
SDI104R-680 □	68	0.213	1.30
SDI104R-820 □	82	0.245	1.15
SDI104R-101 □	100	0.304	1.00

CORE MASTER ENTERPRISE CO., LTD.



<http://www.coremaster.com.tw>

SHIELDED SMD POWER INDUCTORS / SDI TYPE

ELECTRICAL CHARACTERISTICS FOR SDI104R

Part No.	Inductance (uH)	RDC (Ω)	IDC (A)
SDI104R-121 □	120	0.500	0.90
SDI104R-151 □	150	0.560	0.88
SDI104R-181 □	180	0.630	0.80
SDI104R-221 □	220	0.756	0.70
SDI104R-331 □	330	1.500	0.46

ELECTRICAL CHARACTERISTICS FOR SDI105R

Part No.	Inductance (uH)	RDC (Ω)	IDC (A)
SDI105R-2R2 □	2.2	0.009	8.50
SDI105R-3R3 □	3.3	0.011	7.20
SDI105R-4R7 □	4.7	0.019	5.00
SDI105R-6R8 □	6.8	0.025	4.60
SDI105R-8R2 □	8.2	0.030	4.00
SDI105R-100 □	10	0.035	3.50
SDI105R-150 □	15	0.041	3.00
SDI105R-220 □	22	0.061	2.20
SDI105R-330 □	33	0.090	2.00
SDI105R-470 □	47	0.125	1.80
SDI105R-560 □	56	0.130	1.40
SDI105R-680 □	68	0.201	1.35
SDI105R-101 □	100	0.210	1.05
SDI105R-121 □	120	0.230	0.92
SDI105R-151 □	150	0.270	0.90
SDI105R-181 □	180	0.300	0.85
SDI105R-221 □	220	0.400	0.70
SDI105R-331 □	330	0.800	0.60
SDI105R-471 □	470	1.280	0.50
SDI105R-561 □	560	1.300	0.47
SDI105R-681 □	680	1.350	0.39
SDI105R-821 □	820	2.000	0.30
SDI105R-102 □	1000	2.150	0.28

* 100uH 以上 Test Frequency : 1KHZ/1V

* 100uH 以下 Test Frequency : 100KHZ/0.1V

CORE MASTER ENTERPRISE CO., LTD.

<http://www.coremaster.com.tw>



SHIELDED SMD POWER INDUCTORS / SCI TYPE

FEATURES

- ◆ Low DC resistance
- ◆ Suitable for large currents
- ◆ Available in magnetically shielded
- ◆ Small size with the electrode attached to it



APPLICATIONS

- ◆ Power supply for VTRs.
- ◆ Portable communication equipment.
- ◆ LCD televisions.
- ◆ DC to DC converters, etc.

ORDERING CODE

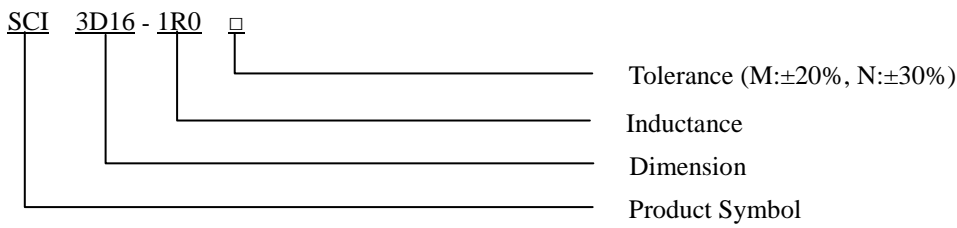

SHAPES

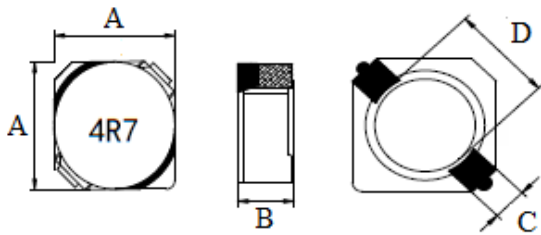

Fig 1.

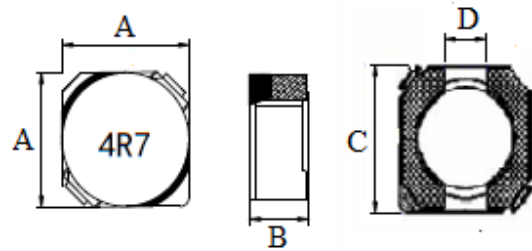

Fig 2.

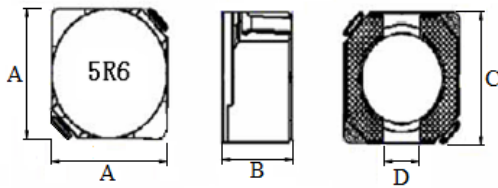

Fig 3.

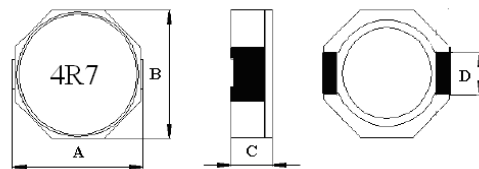

Fig 4.

SHIELDED SMD POWER INDUCTORS / SCI TYPE

DIMENSIONS (UNIT: mm)

Part No.	Fig.	A (Max)	B (Max)	C (Ref.)	D (Ref.)
SCI 2D09	1	3.2	1.1	1.00	2.1
SCI 2D11	1	3.2	1.3	1.00	2.1
SCI 2D14	1	3.2	1.6	1.00	2.1
SCI 2D18	1	3.2	2.0	1.00	2.1
SCI 3D11	2	4.0	1.3	3.75	1.2
SCI 3D14	2	4.0	1.8	3.75	1.2
SCI 3D16	2	4.0	1.9	3.75	1.2
SCI 3D23	2	4.0	2.5	3.75	1.2
SCI 3D28	2	4.0	3.0	3.75	1.2
SCI 4D18	3	5.0	2.0	4.50	1.6
SCI 4D28	3	5.0	3.0	4.50	1.6
SCI 5D18	3	6.0	2.0	5.60	2.0
SCI 5D28	3	6.0	3.0	5.60	2.0
SCI 6D28	3	7.0	3.0	6.50	2.0
SCI 6D38	3	7.0	4.0	6.50	2.0
SCI 8D28	4	9.5	8.4	3.20 (Max)	2.5
SCI 8D43	4	9.5	8.4	5.00 (Max)	2.5

ELECTRICAL CHARACTERISTICS FOR SCI2D09

Part No.	Inductance (uH)	RDC (Ω)	IDC (A)
SCI2D09-3R0 □	3.0	0.165	0.45
SCI2D09-4R7 □	4.7	0.270	0.40
SCI2D09-100 □	10	0.620	0.30
SCI2D09-220 □	22	1.289	0.17

ELECTRICAL CHARACTERISTICS FOR SCI2D11

Part No.	Inductance (uH)	RDC (Ω)	IDC (A)
SCI2D11-1R0 □	1.0	0.085	1.20
SCI2D11-1R5 □	1.5	0.090	1.00
SCI2D11-2R2 □	2.2	0.125	0.78
SCI2D11-3R3 □	3.3	0.160	0.45
SCI2D11-4R7 □	4.7	0.170	0.40
SCI2D11-6R8 □	6.8	0.350	0.38
SCI2D11-8R2 □	8.2	0.400	0.35
SCI2D11-100 □	10	0.580	0.30
SCI2D11-150 □	15	0.730	0.24
SCI2D11-220 □	22	0.950	0.18

CORE MASTER ENTERPRISE CO., LTD.



<http://www.coremaster.com.tw>

SHIELDED SMD POWER INDUCTORS / SCI TYPE

ELECTRICAL CHARACTERISTICS FOR SCI2D14

Part No.	Inductance (uH)	RDC (Ω)	IDC (A)
SCI2D14-1R0 □	1.0	0.080	1.30
SCI2D14-1R5 □	1.5	0.085	1.25
SCI2D14-2R2 □	2.2	0.094	0.80
SCI2D14-3R3 □	3.3	0.145	0.70
SCI2D14-4R7 □	4.7	0.169	0.65
SCI2D14-5R6 □	5.6	0.250	0.60
SCI2D14-6R8 □	6.8	0.260	0.55
SCI2D14-100 □	10	0.550	0.40
SCI2D14-220 □	22	0.900	0.25
SCI2D14-470 □	47	2.300	0.18

ELECTRICAL CHARACTERISTICS FOR SCI2D18

Part No.	Inductance (uH)	RDC (Ω)	IDC (A)
SCI2D18-1R0 □	1.0	0.070	1.40
SCI2D18-1R5 □	1.5	0.080	1.30
SCI2D18-2R2 □	2.2	0.090	0.90
SCI2D18-3R3 □	3.3	0.094	0.80
SCI2D18-4R7 □	4.7	0.100	0.68
SCI2D18-6R8 □	6.8	0.150	0.57
SCI2D18-100 □	10	0.180	0.46
SCI2D18-150 □	15	0.250	0.35
SCI2D18-220 □	22	0.300	0.28
SCI2D18-330 □	33	0.600	0.23
SCI2D18-101 □	100	1.860	0.15

ELECTRICAL CHARACTERISTICS FOR SCI3D11

Part No.	Inductance (uH)	RDC (Ω)	IDC (A)
SCI3D11-2R2 □	2.2	0.125	0.90
SCI3D11-3R3 □	3.3	0.150	0.60
SCI3D11-4R7 □	4.7	0.170	0.50
SCI3D11-6R8 □	6.8	0.200	0.40
SCI3D11-100 □	10	0.350	0.30
SCI3D11-220 □	22	0.920	0.20
SCI3D11-101 □	100	3.200	0.15

ELECTRICAL CHARACTERISTICS FOR SCI3D14

Part No.	Inductance (uH)	RDC (Ω)	IDC (A)
SCI3D14-4R7 □	4.7	0.158	0.70
SCI3D14-100 □	10	0.268	0.48

SHIELDED SMD POWER INDUCTORS / SCI TYPE

ELECTRICAL CHARACTERISTICS FOR SCI3D16

Part No.	Inductance (uH)	RDC (Ω)	IDC (A)
SCI3D16-1R2 □	1.2	0.050	1.80
SCI3D16-2R2 □	2.2	0.060	1.00
SCI3D16-3R3 □	3.3	0.080	0.92
SCI3D16-4R7 □	4.7	0.091	0.80
SCI3D16-6R8 □	6.8	0.145	0.58
SCI3D16-100 □	10	0.170	0.48
SCI3D16-150 □	15	0.230	0.40
SCI3D16-220 □	22	0.290	0.31
SCI3D16-270 □	27	0.410	0.29
SCI3D16-330 □	33	0.550	0.25
SCI3D16-470 □	47	0.775	0.22
SCI3D16-680 □	68	1.100	0.18
SCI3D16-101 □	100	1.400	0.17
SCI3D16-102 □	1000	20.400	0.06

ELECTRICAL CHARACTERISTICS FOR SCI3D23

Part No.	Inductance (uH)	RDC (Ω)	IDC (A)
SCI3D23-1R0 □	1.0	0.025	2.80
SCI3D23-1R5 □	1.5	0.029	2.20
SCI3D23-2R2 □	2.2	0.038	1.80
SCI3D23-3R3 □	3.3	0.056	1.60
SCI3D23-4R7 □	4.7	0.069	1.30
SCI3D23-5R6 □	5.6	0.075	1.10
SCI3D23-6R8 □	6.8	0.088	1.00
SCI3D23-8R2 □	8.2	0.095	0.95
SCI3D23-100 □	10	0.117	0.85
SCI3D23-120 □	12	0.180	0.80
SCI3D23-150 □	15	0.191	0.70
SCI3D23-180 □	18	0.230	0.58
SCI3D23-220 □	22	0.270	0.55
SCI3D23-330 □	33	0.381	0.50
SCI3D23-470 □	47	0.546	0.35
SCI3D23-560 □	56	0.900	0.34
SCI3D23-680 □	68	1.000	0.33
SCI3D23-820 □	82	1.400	0.32
SCI3D23-101 □	100	1.600	0.30
SCI3D23-121 □	120	1.800	0.28
SCI3D23-151 □	150	1.900	0.25
SCI3D23-181 □	180	2.100	0.22
SCI3D23-221 □	220	3.000	0.15

CORE MASTER ENTERPRISE CO., LTD.

<http://www.coremaster.com.tw>



SHIELDED SMD POWER INDUCTORS / SCI TYPE

ELECTRICAL CHARACTERISTICS FOR SCI3D28

Part No.	Inductance (uH)	RDC (Ω)	IDC (A)
SCI3D28-1R0 □	1.0	0.040	2.00
SCI3D28-2R2 □	2.2	0.045	1.00
SCI3D28-3R3 □	3.3	0.050	0.97
SCI3D28-3R9 □	3.9	0.058	0.95
SCI3D28-4R7 □	4.7	0.060	0.90
SCI3D28-5R6 □	5.6	0.065	0.80
SCI3D28-8R2 □	8.2	0.070	0.70
SCI3D28-100 □	10	0.080	0.53
SCI3D28-120 □	12	0.090	0.50
SCI3D28-150 □	15	0.095	0.46
SCI3D28-220 □	22	0.144	0.40
SCI3D28-330 □	33	0.450	0.30
SCI3D28-390 □	39	0.500	0.25
SCI3D28-470 □	47	0.550	0.23
SCI3D28-560 □	56	0.600	0.20
SCI3D28-680 □	68	0.650	0.19
SCI3D28-101 □	100	0.720	0.17
SCI3D28-151 □	150	0.880	0.16
SCI3D28-181 □	180	1.130	0.15
SCI3D28-221 □	220	1.260	0.13

CORE MASTER ENTERPRISE CO., LTD.

<http://www.coremaster.com.tw>



SHIELDED SMD POWER INDUCTORS / SCI TYPE

ELECTRICAL CHARACTERISTICS FOR SCI4D18

Part No.	Inductance (uH)	RDC (Ω)	IDC (A)
SCI4D18-1R0 □	1.0	0.035	2.70
SCI4D18-1R5 □	1.5	0.045	2.50
SCI4D18-2R2 □	2.2	0.060	2.20
SCI4D18-3R3 □	3.3	0.070	1.60
SCI4D18-3R9 □	3.9	0.072	1.50
SCI4D18-4R7 □	4.7	0.100	1.20
SCI4D18-6R8 □	6.8	0.150	1.00
SCI4D18-8R2 □	8.2	0.180	0.90
SCI4D18-100 □	10	0.200	0.85
SCI4D18-150 □	15	0.240	0.80
SCI4D18-180 □	18	0.280	0.60
SCI4D18-220 □	22	0.300	0.55
SCI4D18-330 □	33	0.550	0.50
SCI4D18-470 □	47	0.630	0.43
SCI4D18-101 □	100	2.000	0.20
SCI4D18-181 □	180	2.600	0.19
SCI4D18-221 □	220	2.800	0.15
SCI4D18-471 □	470	5.000	0.13
SCI4D18-681 □	680	10.080	0.12

SHIELDED SMD POWER INDUCTORS / SCI TYPE

ELECTRICAL CHARACTERISTICS FOR SCI4D28

Part No.	Inductance (uH)	RDC (Ω)	IDC (A)
SCI4D28-1R0 □	1.0	0.028	5.00
SCI4D28-1R5 □	1.5	0.030	3.70
SCI4D28-2R2 □	2.2	0.031	3.00
SCI4D28-3R3 □	3.3	0.049	2.30
SCI4D28-3R9 □	3.9	0.058	2.20
SCI4D28-4R7 □	4.7	0.072	2.10
SCI4D28-6R8 □	6.8	0.090	1.70
SCI4D28-8R2 □	8.2	0.120	1.50
SCI4D28-100 □	10	0.128	1.40
SCI4D28-120 □	12	0.132	1.23
SCI4D28-150 □	15	0.149	1.10
SCI4D28-180 □	18	0.250	1.00
SCI4D28-220 □	22	0.270	0.95
SCI4D28-330 □	33	0.300	0.80
SCI4D28-390 □	39	0.400	0.70
SCI4D28-470 □	47	0.478	0.63
SCI4D28-101 □	100	1.000	0.43
SCI4D28-151 □	150	1.500	0.35
SCI4D28-181 □	180	1.700	0.33
SCI4D28-221 □	220	2.000	0.30
SCI4D28-331 □	330	4.000	0.28

ELECTRICAL CHARACTERISTICS FOR SCI5D18

Part No.	Inductance (uH)	RDC (Ω)	IDC (A)
SCI5D18-1R2 □	1.2	0.032	4.00
SCI5D18-2R2 □	2.2	0.045	2.50
SCI5D18-3R3 □	3.3	0.060	2.00
SCI5D18-4R7 □	4.7	0.072	1.60
SCI5D18-6R8 □	6.8	0.105	1.35
SCI5D18-100 □	10	0.124	1.20
SCI5D18-150 □	15	0.160	0.85
SCI5D18-180 □	18	0.200	0.80
SCI5D18-220 □	22	0.280	0.60
SCI5D18-330 □	33	0.400	0.55
SCI5D18-470 □	47	0.500	0.50
SCI5D18-680 □	68	0.800	0.40
SCI5D18-101 □	100	0.950	0.30
SCI5D18-121 □	120	1.100	0.25
SCI5D18-181 □	180	1.950	0.23
SCI5D18-391 □	390	4.100	0.20

CORE MASTER ENTERPRISE CO., LTD.

<http://www.coremaster.com.tw>



SHIELDED SMD POWER INDUCTORS / SCI TYPE

ELECTRICAL CHARACTERISTICS FOR SCI5D28

Part No.	Inductance (uH)	RDC (Ω)	IDC (A)
SCI5D28-1R0 □	1.0	0.020	4.00
SCI5D28-1R5 □	1.5	0.030	3.00
SCI5D28-2R2 □	2.2	0.035	2.60
SCI5D28-2R7 □	2.7	0.037	2.20
SCI5D28-3R3 □	3.3	0.039	2.10
SCI5D28-3R9 □	3.9	0.040	2.00
SCI5D28-4R7 □	4.7	0.045	1.80
SCI5D28-5R6 □	5.6	0.050	1.60
SCI5D28-6R8 □	6.8	0.053	1.50
SCI5D28-8R2 □	8.2	0.055	1.35
SCI5D28-100 □	10	0.065	1.30
SCI5D28-120 □	12	0.075	1.20
SCI5D28-150 □	15	0.090	1.10
SCI5D28-180 □	18	0.100	0.85
SCI5D28-220 □	22	0.122	0.75
SCI5D28-330 □	33	0.180	0.70
SCI5D28-390 □	39	0.200	0.60
SCI5D28-470 □	47	0.260	0.55
SCI5D28-560 □	56	0.305	0.50
SCI5D28-680 □	68	0.355	0.42
SCI5D28-101 □	100	0.520	0.37
SCI5D28-121 □	120	0.550	0.33
SCI5D28-151 □	150	0.800	0.30
SCI5D28-181 □	180	1.000	0.28
SCI5D28-221 □	220	1.100	0.23

SHIELDED SMD POWER INDUCTORS / SCI TYPE

ELECTRICAL CHARACTERISTICS FOR SCI6D28

Part No.	Inductance (uH)	RDC (Ω)	IDC (A)
SCI6D28-1R2 □	1.2	0.025	4.50
SCI6D28-1R5 □	1.5	0.027	4.30
SCI6D28-2R2 □	2.2	0.030	3.50
SCI6D28-3R3 □	3.3	0.032	3.20
SCI6D28-3R9 □	3.9	0.035	3.00
SCI6D28-4R7 □	4.7	0.036	2.80
SCI6D28-5R6 □	5.6	0.040	2.40
SCI6D28-6R8 □	6.8	0.045	2.10
SCI6D28-100 □	10	0.065	1.70
SCI6D28-150 □	15	0.084	1.20
SCI6D28-220 □	22	0.110	1.00
SCI6D28-330 □	33	0.165	0.80
SCI6D28-470 □	47	0.238	0.65
SCI6D28-560 □	56	0.277	0.60
SCI6D28-680 □	68	0.304	0.55
SCI6D28-101 □	100	0.505	0.50
SCI6D28-151 □	150	0.550	0.36
SCI6D28-221 □	220	1.000	0.30

SHIELDED SMD POWER INDUCTORS / SCI TYPE

ELECTRICAL CHARACTERISTICS FOR SCI6D38

Part No.	Inductance (uH)	RDC (Ω)	IDC (A)
SCI6D38-1R0 □	1.0	0.024	5.00
SCI6D38-2R2 □	2.2	0.028	3.60
SCI6D38-2R7 □	2.7	0.030	3.40
SCI6D38-3R3 □	3.3	0.031	3.30
SCI6D38-4R7 □	4.7	0.035	3.20
SCI6D38-5R6 □	5.6	0.037	2.80
SCI6D38-6R8 □	6.8	0.044	2.40
SCI6D38-8R2 □	8.2	0.058	2.20
SCI6D38-100 □	10	0.063	2.00
SCI6D38-150 □	15	0.080	1.60
SCI6D38-220 □	22	0.096	1.30
SCI6D38-330 □	33	0.130	1.10
SCI6D38-390 □	39	0.138	1.00
SCI6D38-470 □	47	0.155	0.90
SCI6D38-560 □	56	0.190	0.82
SCI6D38-680 □	68	0.234	0.75
SCI6D38-101 □	100	0.368	0.63
SCI6D38-151 □	150	0.450	0.43
SCI6D38-221 □	220	0.800	0.35
SCI6D38-331 □	330	1.000	0.34
SCI6D38-471 □	470	1.300	0.27

ELECTRICAL CHARACTERISTICS FOR SCI8D28

Part No.	Inductance (uH)	RDC (Ω)	IDC (A)
SCI8D28-1R0 □	1.0	0.021	5.50
SCI8D28-4R7 □	4.7	0.040	3.90
SCI8D28-5R6 □	5.6	0.045	3.50
SCI8D28-6R8 □	6.8	0.050	3.40
SCI8D28-100 □	10	0.070	3.00
SCI8D28-220 □	22	0.099	1.10
SCI8D28-101 □	100	0.500	0.65

CORE MASTER ENTERPRISE CO., LTD.

<http://www.coremaster.com.tw>



SHIELDED SMD POWER INDUCTORS / SCI TYPE

ELECTRICAL CHARACTERISTICS FOR SCI8D43

Part No.	Inductance (uH)	RDC (Ω)	IDC (A)
SCI8D43-1R0 □	1.0	0.016	6.00
SCI8D43-4R7 □	4.7	0.019	5.37
SCI8D43-6R8 □	6.8	0.040	4.50
SCI8D43-100 □	10	0.061	4.00
SCI8D43-150 □	15	0.075	2.00
SCI8D43-220 □	22	0.100	1.50
SCI8D43-330 □	33	0.200	1.30
SCI8D43-470 □	47	0.250	1.20
SCI8D43-680 □	68	0.260	1.10

* 100uH 以上 Test Frequency : 1KHZ/1V

* 100uH 以下 Test Frequency : 100KHZ/0.1V

SHIELDED SMD POWER INDUCTORS / NR TYPE

FEATURES

- ◆ Low profile construction and miniature size
- ◆ Magnetic shielded construction
- ◆ High current saturation
- ◆ For new generation portable product D/D converter unit.



APPLICATIONS

- ◆ For small DC/DC converter (cellular phone, HDD, DVC, DSC, LCD display etc).

ORDERING CODE

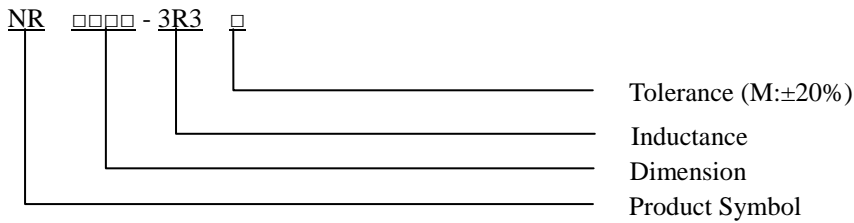

SHAPES

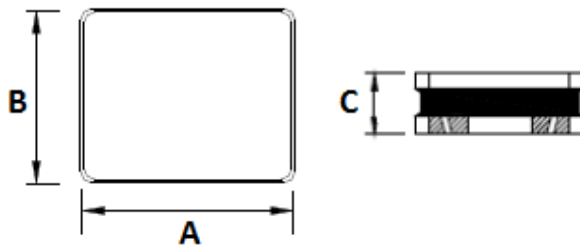

Fig.1

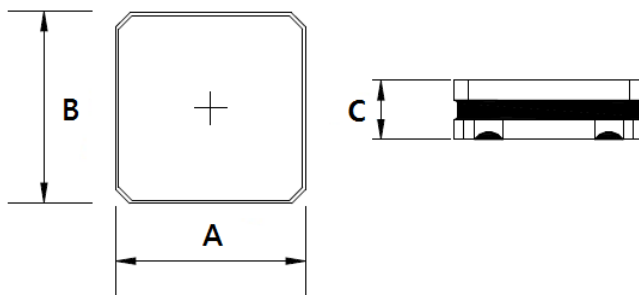

Fig.2

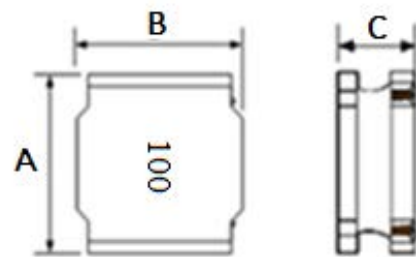

Fig.3

SHIELDED SMD POWER INDUCTORS / NR TYPE

DIMENSIONS (UNIT: mm)

Part No.	Fig.	A	B	C (MAX)
NR 2010	1	2.0 ± 0.2	1.6 ± 0.2	1.1
NR 2012	1	2.0 ± 0.2	1.6 ± 0.2	1.2
NR 2508	1	2.5 ± 0.2	2.0 ± 0.2	0.8
NR 2512	1	2.5 ± 0.2	2.0 ± 0.2	1.2
NR 3010	2	3.0 ± 0.2	3.0 ± 0.2	1.0
NR 3015	2	3.0 ± 0.2	3.0 ± 0.2	1.5
NR 4010	3	4.0 ± 0.2	4.0 ± 0.2	1.0
NR 4018	3	4.0 ± 0.2	4.0 ± 0.2	1.8
NR 4020	3	4.0 ± 0.2	4.0 ± 0.2	2.1
NR 4026	3	4.0 ± 0.2	4.0 ± 0.2	2.8
NR 4030	3	4.0 ± 0.2	4.0 ± 0.2	3.0
NR 5012	3	5.0 ± 0.2	5.0 ± 0.2	1.3
NR 5020	3	5.0 ± 0.2	5.0 ± 0.2	2.0
NR 5040	3	5.0 ± 0.2	5.0 ± 0.2	4.2
NR 6012	3	6.0 ± 0.3	6.0 ± 0.3	1.2
NR 6020	3	6.0 ± 0.3	6.0 ± 0.3	2.0
NR 6028	3	6.0 ± 0.3	6.0 ± 0.3	3.0
NR 6045	3	6.0 ± 0.3	6.0 ± 0.3	4.5
NR 6060	3	6.0 ± 0.3	6.0 ± 0.3	6.3
NR 8040	3	8.0 ± 0.3	8.0 ± 0.3	4.2
NR 8050	3	8.0 ± 0.3	8.0 ± 0.3	5.2
NR 8065	3	8.0 ± 0.3	8.0 ± 0.3	6.8

ELECTRICAL CHARACTERISTICS FOR NR2010

Part No.	Inductance (uH)	Test Frequency	RDC (Ω)	IDC (A)
NR2010-R24 □	0.24	1MHz	0.040	3.70
NR2010-R33 □	0.33	1MHz	0.048	3.00
NR2010-R47 □	0.47	1MHz	0.060	2.30
NR2010-R68 □	0.68	1MHz	0.076	1.95
NR2010-1R0 □	1.00	1MHz	0.114	1.65
NR2010-1R5 □	1.50	1MHz	0.174	1.35
NR2010-2R2 □	2.20	1MHz	0.265	1.20
NR2010-3R3 □	3.30	1MHz	0.345	1.00
NR2010-4R7 □	4.70	1MHz	0.480	0.75
NR2010-6R8 □	6.80	1MHz	0.940	0.68
NR2010-8R2 □	8.20	1MHz	0.800	0.65
NR2010-100 □	10	1MHz	1.000	0.60
NR2010-150 □	15	1MHz	1.700	0.50
NR2010-220 □	22	1MHz	2.000	0.32

CORE MASTER ENTERPRISE CO., LTD.



<http://www.coremaster.com.tw>

SHIELDED SMD POWER INDUCTORS / NR TYPE

ELECTRICAL CHARACTERISTICS FOR NR2012

Part No.	Inductance (uH)	Test Frequency	RDC (Ω)	IDC (A)
NR2012-R47 □	0.47	1MHz	0.051	2.70
NR2012-R68 □	0.68	1MHz	0.074	2.20
NR2012-1R5 □	1.50	1MHz	0.130	1.60
NR2012-6R8 □	6.80	1MHz	0.465	0.82

ELECTRICAL CHARACTERISTICS FOR NR2508

Part No.	Inductance (uH)	Test Frequency	RDC (Ω)	IDC (A)
NR2508-R47 □	0.47	1MHz	0.140	1.80
NR2508-1R0 □	1.00	1MHz	0.219	1.35
NR2508-1R5 □	1.50	1MHz	0.248	1.10
NR2508-2R2 □	2.20	1MHz	0.290	0.86
NR2508-3R3 □	3.30	1MHz	0.416	0.82
NR2508-4R7 □	4.70	1MHz	0.580	0.68
NR2508-6R8 □	6.80	1MHz	0.818	0.55
NR2508-100 □	10	1MHz	1.232	0.48

ELECTRICAL CHARACTERISTICS FOR NR2512

Part No.	Inductance (uH)	Test Frequency	RDC (Ω)	IDC (A)
NR2512-R47 □	0.47	1MHz	0.028	3.50
NR2512-1R0 □	1.00	1MHz	0.043	2.45
NR2512-1R5 □	1.50	1MHz	0.070	2.07
NR2512-2R2 □	2.20	1MHz	0.088	1.95
NR2512-3R3 □	3.30	1MHz	0.130	1.60
NR2512-4R7 □	4.70	1MHz	0.180	1.40
NR2512-6R8 □	6.80	1MHz	0.320	1.04
NR2512-100 □	10	1MHz	0.350	0.77

ELECTRICAL CHARACTERISTICS FOR NR3010

Part No.	Inductance (uH)	Test Frequency	RDC (Ω)	IDC (A)
NR3010-1R0 □	1.00	1MHz	0.078	1.70
NR3010-1R5 □	1.50	1MHz	0.096	1.40
NR3010-2R2 □	2.20	1MHz	0.114	1.25
NR3010-3R3 □	3.30	1MHz	0.192	0.90
NR3010-4R7 □	4.70	1MHz	0.228	0.85
NR3010-6R8 □	6.80	1MHz	0.360	0.66
NR3010-100 □	10	1MHz	0.540	0.53
NR3010-150 □	15	1MHz	0.888	0.42
NR3010-220 □	22	1MHz	1.176	0.36
NR3010-330 □	33	1MHz	1.860	0.28
NR3010-470 □	47	1MHz	2.400	0.24

CORE MASTER ENTERPRISE CO., LTD.

<http://www.coremaster.com.tw>



SHIELDED SMD POWER INDUCTORS / NR TYPE

ELECTRICAL CHARACTERISTICS FOR NR3015

Part No.	Inductance (uH)	Test Frequency	RDC (Ω)	IDC (A)
NR3015-1R0 □	1.00	1MHz	0.048	2.10
NR3015-1R5 □	1.50	1MHz	0.066	1.80
NR3015-2R2 □	2.20	1MHz	0.072	1.48
NR3015-3R3 □	3.30	1MHz	0.112	1.21
NR3015-4R7 □	4.70	1MHz	0.136	1.00
NR3015-6R8 □	6.80	1MHz	0.211	0.90
NR3015-100 □	10	1MHz	0.276	0.75
NR3015-150 □	15	1MHz	0.422	0.58
NR3015-220 □	22	1MHz	0.622	0.47
NR3015-330 □	33	1MHz	0.959	0.39
NR3015-470 □	47	1MHz	1.406	0.32
NR3015-101 □	100	1MHz	2.920	0.23

ELECTRICAL CHARACTERISTICS FOR NR4010

Part No.	Inductance (uH)	Test Frequency	RDC (Ω)	IDC (A)
NR4010-1R0 □	1.0	100KHz	0.067	2.00
NR4010-2R2 □	2.2	100KHz	0.102	1.20
NR4010-3R3 □	3.3	100KHz	0.120	1.10
NR4010-4R7 □	4.7	100KHz	0.168	0.95
NR4010-6R8 □	6.8	100KHz	0.240	0.80
NR4010-100 □	10	100KHz	0.360	0.62
NR4010-150 □	15	100KHz	0.516	0.54
NR4010-220 □	22	100KHz	0.684	0.45

ELECTRICAL CHARACTERISTICS FOR NR4018

Part No.	Inductance (uH)	Test Frequency	RDC (Ω)	IDC (A)
NR4018-1R0 □	1.0	100KHz	0.033	4.80
NR4018-2R2 □	2.2	100KHz	0.059	2.70
NR4018-3R3 □	3.3	100KHz	0.091	2.45
NR4018-4R7 □	4.7	100KHz	0.117	1.70
NR4018-6R8 □	6.8	100KHz	0.143	1.45
NR4018-100 □	10	100KHz	0.234	1.30
NR4018-150 □	15	100KHz	0.325	0.94
NR4018-220 □	22	100KHz	0.468	0.80
NR4018-330 □	33	100KHz	0.689	0.65
NR4018-470 □	47	100KHz	0.845	0.57
NR4018-680 □	68	100KHz	1.300	0.47
NR4018-101 □	100	100KHz	2.275	0.40
NR4018-151 □	150	100KHz	3.250	0.31
NR4018-221 □	220	100KHz	5.200	0.27

CORE MASTER ENTERPRISE CO., LTD.

<http://www.coremaster.com.tw>



SHIELDED SMD POWER INDUCTORS / NR TYPE

ELECTRICAL CHARACTERISTICS FOR NR4020

Part No.	Inductance (uH)	Test Frequency	RDC (Ω)	IDC (A)
NR4020-1R0 □	1.0	100KHz	0.038	4.78
NR4020-1R5 □	1.5	100KHz	0.046	4.45
NR4020-2R2 □	2.2	100KHz	0.052	3.40
NR4020-3R3 □	3.3	100KHz	0.091	3.20
NR4020-4R7 □	4.7	100KHz	0.098	2.35
NR4020-5R6 □	5.6	100KHz	0.117	2.20
NR4020-6R8 □	6.8	100KHz	0.163	2.00
NR4020-8R2 □	8.2	100KHz	0.185	1.75
NR4020-100 □	10	100KHz	0.215	1.60
NR4020-150 □	15	100KHz	0.299	1.35
NR4020-220 □	22	100KHz	0.455	1.05
NR4020-330 □	33	100KHz	0.715	0.85
NR4020-470 □	47	100KHz	0.923	0.74
NR4020-560 □	56	100KHz	1.040	0.66
NR4020-680 □	68	100KHz	1.380	0.61
NR4020-820 □	82	100KHz	1.520	0.50
NR4020-101 □	100	100KHz	2.020	0.48

ELECTRICAL CHARACTERISTICS FOR NR4026

Part No.	Inductance (uH)	Test Frequency	RDC (Ω)	IDC (A)
NR4026-1R0 □	1.0	100KHz	0.033	3.30
NR4026-1R2 □	1.2	100KHz	0.039	3.10
NR4026-1R5 □	1.5	100KHz	0.048	2.40
NR4026-2R2 □	2.2	100KHz	0.052	2.10
NR4026-3R3 □	3.3	100KHz	0.065	1.80
NR4026-4R7 □	4.7	100KHz	0.072	1.60
NR4026-6R8 □	6.8	100KHz	0.085	1.30
NR4026-100 □	10	100KHz	0.170	1.00
NR4026-150 □	15	100KHz	0.250	0.90
NR4026-220 □	22	100KHz	0.330	0.60
NR4026-330 □	33	100KHz	0.480	0.50

CORE MASTER ENTERPRISE CO., LTD.

<http://www.coremaster.com.tw>



SHIELDED SMD POWER INDUCTORS / NR TYPE

ELECTRICAL CHARACTERISTICS FOR NR4030

Part No.	Inductance (uH)	Test Frequency	RDC (Ω)	IDC (A)
NR4030-1R0 □	1.0	100KHz	0.018	5.26
NR4030-1R5 □	1.5	100KHz	0.026	4.84
NR4030-2R2 □	2.2	100KHz	0.039	4.50
NR4030-3R3 □	3.3	100KHz	0.052	3.30
NR4030-4R7 □	4.7	100KHz	0.078	2.90
NR4030-5R6 □	5.6	100KHz	0.085	2.60
NR4030-6R8 □	6.8	100KHz	0.100	2.40
NR4030-8R2 □	8.2	100KHz	0.117	2.10
NR4030-100 □	10	100KHz	0.130	1.95
NR4030-150 □	15	100KHz	0.247	1.65
NR4030-220 □	22	100KHz	0.292	1.30
NR4030-330 □	33	100KHz	0.429	1.10
NR4030-470 □	47	100KHz	0.579	0.95
NR4030-560 □	56	100KHz	0.722	0.85
NR4030-680 □	68	100KHz	1.128	0.72
NR4030-820 □	82	100KHz	1.378	0.66
NR4030-101 □	100	100KHz	1.495	0.60
NR4030-151 □	150	100KHz	2.340	0.50
NR4030-221 □	220	100KHz	3.250	0.40
NR4030-331 □	330	100KHz	5.200	0.30
NR4030-471 □	470	100KHz	9.360	0.25
NR4030-681 □	680	100KHz	9.854	0.19

ELECTRICAL CHARACTERISTICS FOR NR5012

Part No.	Inductance (uH)	Test Frequency	RDC (Ω)	IDC (A)
NR5012-1R0 □	1.0	100KHz	0.068	4.40
NR5012-1R5 □	1.5	100KHz	0.086	3.70
NR5012-2R2 □	2.2	100KHz	0.108	3.10
NR5012-3R3 □	3.3	100KHz	0.151	2.40
NR5012-4R7 □	4.7	100KHz	0.197	2.20
NR5012-6R8 □	6.8	100KHz	0.294	1.70
NR5012-100 □	10	100KHz	0.413	1.40
NR5012-150 □	15	100KHz	0.523	1.20
NR5012-220 □	22	100KHz	0.858	0.88

CORE MASTER ENTERPRISE CO., LTD.



<http://www.coremaster.com.tw>

SHIELDED SMD POWER INDUCTORS / NR TYPE

ELECTRICAL CHARACTERISTICS FOR NR5020

Part No.	Inductance (uH)	Test Frequency	RDC (Ω)	IDC (A)
NR5020-1R0 □	1.0	100KHz	0.026	4.10
NR5020-1R5 □	1.5	100KHz	0.034	4.00
NR5020-2R2 □	2.2	100KHz	0.042	3.80
NR5020-2R7 □	2.7	100KHz	0.049	2.90
NR5020-3R3 □	3.3	100KHz	0.056	2.55
NR5020-3R9 □	3.9	100KHz	0.056	2.30
NR5020-4R7 □	4.7	100KHz	0.074	2.50
NR5020-5R6 □	5.6	100KHz	0.083	2.30
NR5020-6R8 □	6.8	100KHz	0.108	2.05
NR5020-8R2 □	8.2	100KHz	0.127	1.85
NR5020-100 □	10	100KHz	0.143	1.70
NR5020-120 □	12	100KHz	0.182	1.50
NR5020-150 □	15	100KHz	0.215	1.35
NR5020-180 □	18	100KHz	0.260	1.25
NR5020-220 □	22	100KHz	0.294	1.15
NR5020-330 □	33	100KHz	0.507	0.92
NR5020-470 □	47	100KHz	0.680	0.85
NR5020-560 □	56	100KHz	0.819	0.77
NR5020-680 □	68	100KHz	0.962	0.65
NR5020-820 □	82	100KHz	1.158	0.59
NR5020-101 □	100	100KHz	1.430	0.53
NR5020-121 □	120	100KHz	1.755	0.42

ELECTRICAL CHARACTERISTICS FOR NR5040

Part No.	Inductance (uH)	Test Frequency	RDC (Ω)	IDC (A)
NR5040-1R0 □	1.0	100KHz	0.016	7.35
NR5040-1R5 □	1.5	100KHz	0.020	6.30
NR5040-1R8 □	1.8	100KHz	0.021	5.50
NR5040-2R2 □	2.2	100KHz	0.025	4.90
NR5040-3R3 □	3.3	100KHz	0.031	3.95
NR5040-4R7 □	4.7	100KHz	0.039	3.50
NR5040-5R6 □	5.6	100KHz	0.046	3.00
NR5040-6R8 □	6.8	100KHz	0.056	2.90
NR5040-8R2 □	8.2	100KHz	0.062	2.70
NR5040-100 □	10	100KHz	0.083	2.35
NR5040-150 □	15	100KHz	0.112	2.00
NR5040-220 □	22	100KHz	0.168	1.60
NR5040-330 □	33	100KHz	0.244	1.30
NR5040-470 □	47	100KHz	0.354	1.10

CORE MASTER ENTERPRISE CO., LTD.



<http://www.coremaster.com.tw>

SHIELDED SMD POWER INDUCTORS / NR TYPE

ELECTRICAL CHARACTERISTICS FOR NR5040

Part No.	Inductance (uH)	Test Frequency	RDC (Ω)	IDC (A)
NR5040-680 □	68	100KHz	0.520	0.90
NR5040-101 □	100	100KHz	0.728	0.75
NR5040-151 □	150	100KHz	0.975	0.65
NR5040-102 □	1000	100KHz	7.800	0.21

ELECTRICAL CHARACTERISTICS FOR NR6012

Part No.	Inductance (uH)	Test Frequency	RDC (Ω)	IDC (A)
NR6012-1R0 □	1.0	100KHz	0.060	3.00
NR6012-1R5 □	1.5	100KHz	0.080	2.60
NR6012-2R2 □	2.2	100KHz	0.108	2.10
NR6012-3R3 □	3.3	100KHz	0.126	1.80
NR6012-4R7 □	4.7	100KHz	0.150	1.60
NR6012-6R8 □	6.8	100KHz	0.198	1.30
NR6012-100 □	10	100KHz	0.240	1.00
NR6012-150 □	15	100KHz	0.354	0.80
NR6012-220 □	22	100KHz	0.558	0.76
NR6012-330 □	33	100KHz	0.696	0.59
NR6012-470 □	47	100KHz	1.158	0.52
NR6012-680 □	68	100KHz	1.392	0.44
NR6012-101 □	100	100KHz	2.004	0.35

ELECTRICAL CHARACTERISTICS FOR NR6020

Part No.	Inductance (uH)	Test Frequency	RDC (Ω)	IDC (A)
NR6020-1R5 □	1.5	100KHz	0.031	4.30
NR6020-2R2 □	2.2	100KHz	0.041	3.20
NR6020-3R3 □	3.3	100KHz	0.048	2.80
NR6020-4R7 □	4.7	100KHz	0.070	2.40
NR6020-6R8 □	6.8	100KHz	0.102	2.00
NR6020-100 □	10	100KHz	0.150	1.90
NR6020-220 □	22	100KHz	0.348	1.25

SHIELDED SMD POWER INDUCTORS / NR TYPE

ELECTRICAL CHARACTERISTICS FOR NR6028

Part No.	Inductance (uH)	Test Frequency	RDC (Ω)	IDC (A)
NR6028-0R9 □	0.9	100KHz	0.017	6.70
NR6028-1R5 □	1.5	100KHz	0.021	5.10
NR6028-2R2 □	2.2	100KHz	0.026	4.20
NR6028-4R7 □	4.7	100KHz	0.040	2.70
NR6028-6R8 □	6.8	100KHz	0.056	2.50
NR6028-100 □	10	100KHz	0.085	1.90
NR6028-150 □	15	100KHz	0.124	1.60
NR6028-220 □	22	100KHz	0.176	1.30
NR6028-330 □	33	100KHz	0.286	1.10
NR6028-470 □	47	100KHz	0.390	1.00
NR6028-680 □	68	100KHz	0.546	0.80
NR6028-101 □	100	100KHz	0.780	0.65

ELECTRICAL CHARACTERISTICS FOR NR6045

Part No.	Inductance (uH)	Test Frequency	RDC (Ω)	IDC (A)
NR6045-1R0 □	1.0	100KHz	0.013	12.20
NR6045-1R5 □	1.5	100KHz	0.020	9.60
NR6045-1R8 □	1.8	100KHz	0.021	8.64
NR6045-2R2 □	2.2	100KHz	0.025	7.92
NR6045-3R3 □	3.3	100KHz	0.032	6.75
NR6045-4R7 □	4.7	100KHz	0.041	6.03
NR6045-5R6 □	5.6	100KHz	0.052	4.95
NR6045-6R8 □	6.8	100KHz	0.058	4.77
NR6045-8R2 □	8.2	100KHz	0.069	4.10
NR6045-100 □	10	100KHz	0.070	4.05
NR6045-150 □	15	100KHz	0.104	3.06
NR6045-220 □	22	100KHz	0.116	2.05
NR6045-330 □	33	100KHz	0.179	1.65
NR6045-470 □	47	100KHz	0.288	1.40
NR6045-680 □	68	100KHz	0.429	1.25
NR6045-101 □	100	100KHz	0.650	1.17
NR6045-121 □	120	100KHz	0.730	0.85
NR6045-151 □	150	100KHz	0.854	0.70
NR6045-221 □	220	100KHz	1.690	0.60
NR6045-331 □	330	100KHz	2.340	0.50
NR6045-471 □	470	100KHz	2.847	0.40
NR6045-681 □	680	100KHz	3.550	0.33
NR6045-102 □	1000	100KHz	6.218	0.30
NR6045-152 □	1500	100KHz	9.025	0.20

CORE MASTER ENTERPRISE CO., LTD.



<http://www.coremaster.com.tw>

SHIELDED SMD POWER INDUCTORS / NR TYPE

ELECTRICAL CHARACTERISTICS FOR NR6060

Part No.	Inductance (uH)	Test Frequency	RDC (Ω)	IDC (A)
NR6060-1R0 □	1.0	100KHz	0.010	10.00
NR6060-2R2 □	2.2	100KHz	0.020	8.80
NR6060-3R3 □	3.3	100KHz	0.025	7.50
NR6060-4R7 □	4.7	100KHz	0.033	6.80
NR6060-6R8 □	6.8	100KHz	0.040	5.90
NR6060-100 □	10	100KHz	0.072	4.60
NR6060-150 □	15	100KHz	0.098	3.80
NR6060-220 □	22	100KHz	0.111	3.40
NR6060-330 □	33	100KHz	0.156	2.80

ELECTRICAL CHARACTERISTICS FOR NR8040

Part No.	Inductance (uH)	Test Frequency	RDC (Ω)	IDC (A)
NR8040-1R0 □	1.0	100KHz	0.010	9.85
NR8040-2R2 □	2.2	100KHz	0.016	7.10
NR8040-3R3 □	3.3	100KHz	0.022	6.50
NR8040-4R7 □	4.7	100KHz	0.025	5.90
NR8040-5R6 □	5.6	100KHz	0.030	6.00
NR8040-6R8 □	6.8	100KHz	0.031	4.55
NR8040-8R2 □	8.2	100KHz	0.034	4.20
NR8040-100 □	10	100KHz	0.038	3.60
NR8040-150 □	15	100KHz	0.061	2.95
NR8040-220 □	22	100KHz	0.090	2.40
NR8040-330 □	33	100KHz	0.126	2.05
NR8040-470 □	47	100KHz	0.177	1.75
NR8040-680 □	68	100KHz	0.255	1.45
NR8040-820 □	82	100KHz	0.293	1.30
NR8040-101 □	100	100KHz	0.442	1.15
NR8040-151 □	150	100KHz	0.533	1.10
NR8040-221 □	220	100KHz	0.779	0.85
NR8040-331 □	330	100KHz	1.156	0.68
NR8040-471 □	470	100KHz	1.950	0.60
NR8040-681 □	680	100KHz	2.652	0.50
NR8040-102 □	1000	100KHz	3.640	0.40

CORE MASTER ENTERPRISE CO., LTD.



<http://www.coremaster.com.tw>

SHIELDED SMD POWER INDUCTORS / NR TYPE

ELECTRICAL CHARACTERISTICS FOR NR8050

Part No.	Inductance (uH)	Test Frequency	RDC (Ω)	IDC (A)
NR8050-4R7 □	4.7	100KHz	0.039	9.50
NR8050-220 □	22	100KHz	0.120	4.00
NR8050-680 □	68	100KHz	0.255	1.55
NR8050-820 □	82	100KHz	0.305	1.40
NR8050-151 □	150	100KHz	0.585	1.20
NR8050-102 □	1000	100KHz	5.000	0.42

ELECTRICAL CHARACTERISTICS FOR NR8065

Part No.	Inductance (uH)	Test Frequency	RDC (Ω)	IDC (A)
NR8065-4R7 □	4.7	100KHz	0.022	8.50
NR8065-5R6 □	5.6	100KHz	0.026	8.00
NR8065-6R8 □	6.8	100KHz	0.029	7.50
NR8065-8R2 □	8.2	100KHz	0.031	7.00
NR8065-100 □	10	100KHz	0.040	6.60
NR8065-150 □	15	100KHz	0.062	4.80
NR8065-220 □	22	100KHz	0.065	4.30
NR8065-330 □	33	100KHz	0.118	3.50
NR8065-470 □	47	100KHz	0.156	3.00
NR8065-680 □	68	100KHz	0.230	2.70
NR8065-820 □	82	100KHz	0.300	2.50
NR8065-101 □	100	100KHz	0.390	2.30
NR8065-151 □	150	100KHz	0.575	1.80
NR8065-221 □	220	100KHz	0.988	1.40
NR8065-331 □	330	100KHz	1.320	1.10
NR8065-471 □	470	100KHz	1.690	0.90
NR8065-821 □	820	100KHz	2.000	0.65
NR8065-102 □	1000	100KHz	2.820	0.60
NR8065-152 □	1500	100KHz	4.380	0.54
NR8065-302 □	3000	100KHz	10.800	0.30
NR8065-472 □	4700	100KHz	14.580	0.25
NR8065-682 □	6800	100KHz	22.440	0.24

CORE MASTER ENTERPRISE CO., LTD.



<http://www.coremaster.com.tw>

SHIELDED SMD POWER INDUCTORS / FPI (S) TYPE

FEATURES

- ◆ Excellent solderability and high Heat resistance
- ◆ Excellent terminal strength construction
- ◆ Shielded with magnetic resin
- ◆ Closed magnetic design



APPLICATIONS

- ◆ Power supply for VTRs.
- ◆ Portable communication equipment.
- ◆ Notebook PCs.
- ◆ LCD televisions.
- ◆ DC/DC converters, etc.

ORDERING CODE

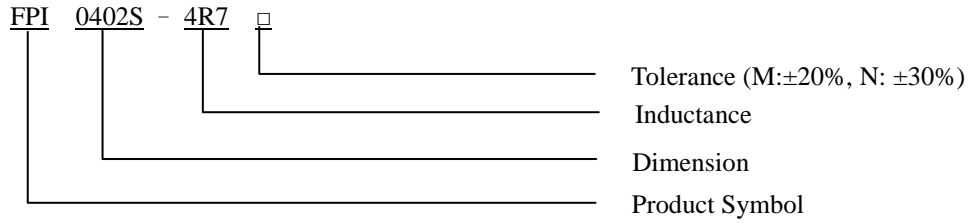

SHAPES

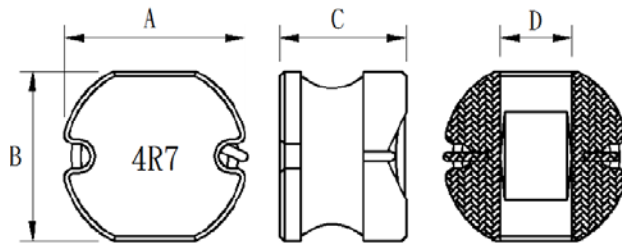

SHIELDED SMD POWER INDUCTORS / FPI (S) TYPE

DIMENSIONS (UNIT: mm)

Part No.	A	B	C	D (Ref.)
FPI 0311S	3.3 ± 0.3	3.0 ± 0.3	1.1 ± 0.3	1.00
FPI 0315S	3.3 ± 0.3	3.0 ± 0.3	1.5 ± 0.3	1.00
FPI 0302S	3.3 ± 0.3	3.0 ± 0.3	2.1 ± 0.3	1.00
FPI 0402S	4.5 ± 0.3	4.0 ± 0.3	2.1 ± 0.3	1.20
FPI 0403S	4.5 ± 0.3	4.0 ± 0.3	3.2 ± 0.3	1.20
FPI 0519S	5.8 ± 0.3	5.2 ± 0.3	2.1 ± 0.3	1.30
FPI 0502S	5.8 ± 0.3	5.2 ± 0.3	2.5 ± 0.3	1.30
FPI 0503S	5.8 ± 0.3	5.2 ± 0.3	3.0 ± 0.3	1.30
FPI 0504S	5.8 ± 0.3	5.2 ± 0.3	4.5 ± 0.3	1.30
FPI 0703S	7.8 ± 0.3	7.0 ± 0.3	3.5 ± 0.3	2.10
FPI 0705S	7.8 ± 0.3	7.0 ± 0.3	5.0 ± 0.3	2.10
FPI 1004S	10.0 ± 0.3	9.0 ± 0.3	4.0 ± 0.4	2.90
FPI 1005S	10.0 ± 0.3	9.0 ± 0.3	5.4 ± 0.4	2.90
FPI 1006S	10.0 ± 0.4	9.0 ± 0.4	6.5 ± 0.3	3.10
FPI 1008S	10.0 ± 0.4	9.0 ± 0.4	8.2 ± 0.3	3.10

ELECTRICAL CHARACTERISTICS FOR FPI0311S

Part No.	Inductance (uH)	RDC (Ω)	IDC (A)
FPI0311S-1R0 □	1.0	0.060	2.00
FPI0311S-2R2 □	2.2	0.140	1.70
FPI0311S-2R7 □	2.7	0.150	1.60
FPI0311S-3R3 □	3.3	0.170	1.50
FPI0311S-4R7 □	4.7	0.300	1.40
FPI0311S-6R8 □	6.8	0.420	1.20
FPI0311S-100 □	10	0.800	1.00
FPI0311S-220 □	22	1.500	0.60

ELECTRICAL CHARACTERISTICS FOR FPI0315S

Part No.	Inductance (uH)	RDC (Ω)	IDC (A)
FPI0315S-2R2 □	2.2	0.140	1.70
FPI0315S-4R7 □	4.7	0.220	1.55
FPI0315S-5R6 □	5.6	0.250	1.30
FPI0315S-6R8 □	6.8	0.380	1.20
FPI0315S-100 □	10	0.450	1.15
FPI0315S-470 □	47	2.500	0.50

SHIELDED SMD POWER INDUCTORS / FPI(S) TYPE

ELECTRICAL CHARACTERISTICS FOR FPI0302S

Part No.	Inductance (uH)	RDC (Ω)	IDC (A)
FPI0302S-1R0 □	1.0	0.054	4.00
FPI0302S-1R5 □	1.5	0.085	3.20
FPI0302S-2R2 □	2.2	0.120	2.50
FPI0302S-2R7 □	2.7	0.140	2.40
FPI0302S-3R3 □	3.3	0.180	2.30
FPI0302S-4R7 □	4.7	0.200	2.20
FPI0302S-5R6 □	5.6	0.210	1.70
FPI0302S-6R8 □	6.8	0.350	1.50
FPI0302S-100 □	10	0.360	1.40
FPI0302S-150 □	15	0.450	1.13
FPI0302S-180 □	18	0.490	0.90
FPI0302S-220 □	22	0.600	0.80
FPI0302S-270 □	27	0.750	0.70
FPI0302S-470 □	47	1.200	0.50
FPI0302S-680 □	68	1.900	0.45

ELECTRICAL CHARACTERISTICS FOR FPI0402S

Part No.	Inductance (uH)	RDC (Ω)	IDC (A)
FPI0402S-1R0 □	1.0	0.020	5.40
FPI0402S-1R5 □	1.5	0.025	4.57
FPI0402S-2R2 □	2.2	0.036	3.50
FPI0402S-3R3 □	3.3	0.051	2.80
FPI0402S-4R7 □	4.7	0.063	2.60
FPI0402S-6R8 □	6.8	0.108	2.05
FPI0402S-100 □	10	0.140	1.70
FPI0402S-150 □	15	0.230	1.35
FPI0402S-220 □	22	0.360	1.17
FPI0402S-330 □	33	0.530	0.94
FPI0402S-470 □	47	0.760	0.79
FPI0402S-680 □	68	0.860	0.65
FPI0402S-101 □	100	1.310	0.54

SHIELDED SMD POWER INDUCTORS / FPI(S) TYPE

ELECTRICAL CHARACTERISTICS FOR FPI0403S

Part No.	Inductance (uH)	RDC (Ω)	IDC (A)
FPI0403S-1R0 □	1.0	0.014	6.00
FPI0403S-1R5 □	1.5	0.020	4.84
FPI0403S-2R2 □	2.2	0.030	4.40
FPI0403S-3R3 □	3.3	0.040	3.30
FPI0403S-4R7 □	4.7	0.060	2.90
FPI0403S-5R6 □	5.6	0.065	2.60
FPI0403S-6R8 □	6.8	0.090	2.45
FPI0403S-8R2 □	8.2	0.095	2.10
FPI0403S-100 □	10	0.100	1.95
FPI0403S-150 □	15	0.190	1.65
FPI0403S-220 □	22	0.220	1.30
FPI0403S-330 □	33	0.330	1.10
FPI0403S-470 □	47	0.440	0.95
FPI0403S-680 □	68	0.870	0.72
FPI0403S-101 □	100	1.150	0.60

ELECTRICAL CHARACTERISTICS FOR FPI0519S

Part No.	Inductance (uH)	RDC (Ω)	IDC (A)
FPI0519S-1R0 □	1.0	0.035	5.70
FPI0519S-2R2 □	2.2	0.062	4.20
FPI0519S-3R9 □	3.9	0.073	3.30
FPI0519S-4R7 □	4.7	0.080	2.50
FPI0519S-6R8 □	6.8	0.170	2.40
FPI0519S-100 □	10	0.180	1.80
FPI0519S-220 □	22	0.450	1.20
FPI0519S-470 □	47	0.750	0.80
FPI0519S-560 □	56	0.800	0.60
FPI0519S-680 □	68	1.150	0.55
FPI0519S-101 □	100	1.500	0.50
FPI0519S-151 □	150	2.000	0.45
FPI0519S-181 □	180	2.500	0.40

SHIELDED SMD POWER INDUCTORS / FPI (S) TYPE

ELECTRICAL CHARACTERISTICS FOR FPI0502S

Part No.	Inductance (uH)	RDC (Ω)	IDC (A)
FPI0502S-1R0 □	1.0	0.020	4.10
FPI0502S-1R5 □	1.5	0.026	3.80
FPI0502S-2R2 □	2.2	0.032	3.20
FPI0502S-3R3 □	3.3	0.043	2.55
FPI0502S-4R7 □	4.7	0.057	2.50
FPI0502S-6R8 □	6.8	0.083	2.05
FPI0502S-100 □	10	0.110	1.70
FPI0502S-150 □	15	0.170	1.35
FPI0502S-220 □	22	0.230	1.15

ELECTRICAL CHARACTERISTICS FOR FPI0503S

Part No.	Inductance (uH)	RDC (Ω)	IDC (A)
FPI0503S-1R0 □	1.0	0.015	6.60
FPI0503S-1R5 □	1.5	0.020	5.00
FPI0503S-2R2 □	2.2	0.023	4.20
FPI0503S-3R3 □	3.3	0.030	3.60
FPI0503S-4R7 □	4.7	0.035	3.10
FPI0503S-6R8 □	6.8	0.052	2.50
FPI0503S-100 □	10	0.070	2.10
FPI0503S-150 □	15	0.125	1.60
FPI0503S-220 □	22	0.180	1.40
FPI0503S-330 □	33	0.225	1.19
FPI0503S-470 □	47	0.325	0.95

ELECTRICAL CHARACTERISTICS FOR FPI0504S

Part No.	Inductance (uH)	RDC (Ω)	IDC (A)
FPI0504S-1R0 □	1.0	0.014	8.50
FPI0504S-1R5 □	1.5	0.018	7.60
FPI0504S-1R8 □	1.8	0.020	7.00
FPI0504S-2R2 □	2.2	0.025	6.00
FPI0504S-3R3 □	3.3	0.030	5.00
FPI0504S-4R7 □	4.7	0.038	4.00
FPI0504S-6R8 □	6.8	0.047	3.80
FPI0504S-8R2 □	8.2	0.060	3.30
FPI0504S-100 □	10	0.070	3.00
FPI0504S-150 □	15	0.100	2.30
FPI0504S-220 □	22	0.140	1.90
FPI0504S-330 □	33	0.190	1.50
FPI0504S-470 □	47	0.260	1.30
FPI0504S-680 □	68	0.350	1.00
FPI0504S-101 □	100	0.490	0.80

CORE MASTER ENTERPRISE CO., LTD.

<http://www.coremaster.com.tw>



SHIELDED SMD POWER INDUCTORS / FPI (S) TYPE

ELECTRICAL CHARACTERISTICS FOR FPI0703S

Part No.	Inductance (uH)	RDC (Ω)	IDC (A)
FPI0703S-1R0 □	1.0	0.010	11.00
FPI0703S-1R5 □	1.5	0.011	8.20
FPI0703S-2R2 □	2.2	0.013	7.40
FPI0703S-3R3 □	3.3	0.021	5.50
FPI0703S-4R7 □	4.7	0.024	4.70
FPI0703S-6R8 □	6.8	0.033	4.20
FPI0703S-100 □	10	0.050	3.40
FPI0703S-150 □	15	0.070	2.70
FPI0703S-220 □	22	0.100	2.20
FPI0703S-330 □	33	0.145	1.90
FPI0703S-470 □	47	0.190	1.50
FPI0703S-680 □	68	0.280	1.20
FPI0703S-101 □	100	0.400	1.00

ELECTRICAL CHARACTERISTICS FOR FPI0705S

Part No.	Inductance (uH)	RDC (Ω)	IDC (A)
FPI0705S-1R0 □	1.0	0.006	13.00
FPI0705S-1R5 □	1.5	0.007	11.00
FPI0705S-2R2 □	2.2	0.012	9.00
FPI0705S-3R3 □	3.3	0.015	7.00
FPI0705S-4R7 □	4.7	0.022	5.60
FPI0705S-6R8 □	6.8	0.027	4.70
FPI0705S-100 □	10	0.042	3.80
FPI0705S-150 □	15	0.057	3.20
FPI0705S-220 □	22	0.079	2.60
FPI0705S-330 □	33	0.104	2.20
FPI0705S-470 □	47	0.140	1.80
FPI0705S-680 □	68	0.200	1.50
FPI0705S-820 □	82	0.250	1.40
FPI0705S-101 □	100	0.300	1.30
FPI0705S-151 □	150	0.480	1.00
FPI0705S-221 □	220	0.680	0.84
FPI0705S-331 □	330	1.030	0.68
FPI0705S-471 □	470	1.540	0.57

SHIELDED SMD POWER INDUCTORS / FPI(S) TYPE

ELECTRICAL CHARACTERISTICS FOR FPI1004S

Part No.	Inductance (uH)	RDC (Ω)	IDC (A)
FPI1004S-1R0 □	1.0	0.006	14.00
FPI1004S-1R5 □	1.5	0.008	11.00
FPI1004S-2R2 □	2.2	0.011	9.00
FPI1004S-3R3 □	3.3	0.014	7.70
FPI1004S-4R7 □	4.7	0.018	6.70
FPI1004S-6R8 □	6.8	0.027	5.30
FPI1004S-100 □	10	0.039	4.30
FPI1004S-150 □	15	0.055	3.50
FPI1004S-220 □	22	0.077	2.90
FPI1004S-330 □	33	0.100	2.40
FPI1004S-470 □	47	0.160	2.00
FPI1004S-680 □	68	0.250	1.60
FPI1004S-101 □	100	0.350	1.40
FPI1004S-151 □	150	0.520	1.10
FPI1004S-221 □	220	0.710	0.94
FPI1004S-331 □	330	1.190	0.75
FPI1004S-471 □	470	1.600	0.64

ELECTRICAL CHARACTERISTICS FOR FPI1005S

Part No.	Inductance (uH)	RDC (Ω)	IDC (A)
FPI1005S-1R5 □	1.5	0.008	12.00
FPI1005S-2R2 □	2.2	0.010	9.20
FPI1005S-3R3 □	3.3	0.013	7.50
FPI1005S-4R7 □	4.7	0.022	7.00
FPI1005S-6R8 □	6.8	0.027	5.70
FPI1005S-100 □	10	0.035	4.80
FPI1005S-150 □	15	0.050	3.80
FPI1005S-220 □	22	0.073	3.00
FPI1005S-330 □	33	0.093	2.50
FPI1005S-470 □	47	0.128	2.10
FPI1005S-560 □	56	0.150	2.00
FPI1005S-680 □	68	0.210	1.80
FPI1005S-101 □	100	0.300	1.50
FPI1005S-151 □	150	0.500	1.20
FPI1005S-221 □	220	0.750	1.00
FPI1005S-331 □	330	1.100	0.80

SHIELDED SMD POWER INDUCTORS / FPI(S) TYPE

ELECTRICAL CHARACTERISTICS FOR FPI1006S

Part No.	Inductance (uH)	RDC (Ω)	IDC (A)
FPI1006S-1R5 □	1.5	0.020	20.00
FPI1006S-3R3 □	3.3	0.030	15.00
FPI1006S-100 □	10	0.050	9.20
FPI1006S-220 □	22	0.075	6.20
FPI1006S-330 □	33	0.100	4.50
FPI1006S-390 □	39	0.110	3.80
FPI1006S-470 □	47	0.140	2.40
FPI1006S-560 □	56	0.160	2.00
FPI1006S-680 □	68	0.200	1.75
FPI1006S-101 □	100	0.218	1.70
FPI1006S-121 □	120	0.280	1.60
FPI1006S-151 □	150	0.330	1.50
FPI1006S-221 □	220	0.600	1.40
FPI1006S-102 □	1000	3.500	0.45

ELECTRICAL CHARACTERISTICS FOR FPI1008S

Part No.	Inductance (uH)	RDC (Ω)	IDC (A)
FPI1008S-6R8 □	6.8	0.026	9.50
FPI1008S-330 □	33	0.055	4.50
FPI1008S-470 □	47	0.111	2.50
FPI1008S-680 □	68	0.150	1.80
FPI1008S-581 □	580	0.810	1.00
FPI1008S-681 □	680	1.180	0.95
FPI1008S-751 □	750	1.300	0.90
FPI1008S-102 □	1000	1.650	0.60

* Test Frequency : 100KHZ/0.25V.



CORE MASTER ENTERPRISE CO., LTD.

<http://www.coremaster.com.tw>

SMD POWER INDUCTORS / WDI TYPE

FEATURES

- ◆ The series is a range of miniature, surface-mount.
- ◆ I-core power inductors.
- ◆ Suitable for and reflow soldering.
- ◆ They are designed for use in power applications with restricted PCB space and height.



APPLICATIONS

- ◆ Personal computers.
- ◆ Pagers, Cordless phone.
- ◆ High Freq. Communication Products.
- ◆ Disk Drives and computer peripherals.
- DC power supply circuits.

ORDERING CODE

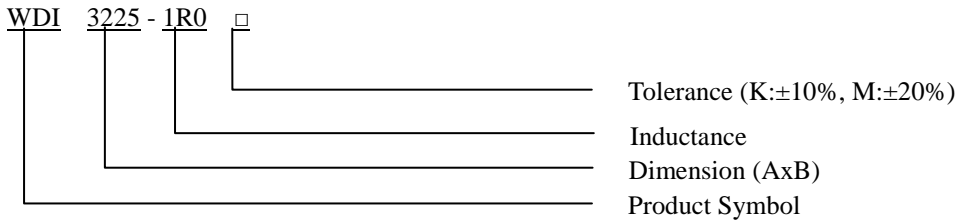

SHAPES

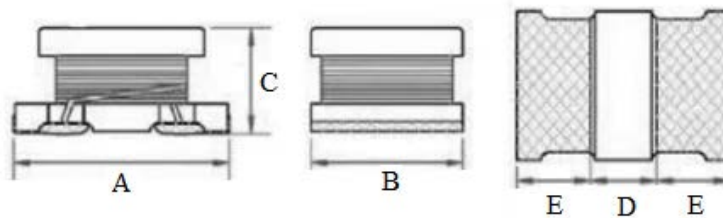

DIMENSIONS UNIT: mm (inch)

Part No.	A	B	C	D (MIN)	E (MIN)
WDI 3216 (1206)	3.2 ± 0.3	1.6 ± 0.2	1.8 ± 0.3	0.7	0.7
WDI 3225 (1210)	3.2 ± 0.3	2.5 ± 0.2	2.0 ± 0.3	0.7	0.7
WDI 4532 (1812)	4.5 ± 0.3	3.2 ± 0.2	2.6 ± 0.3	1.0	1.0
WDI 5750 (2220)	5.7 ± 0.3	5.0 ± 0.3	4.7 ± 0.3	1.7	1.3

SMD POWER INDUCTORS / WDI TYPE

ELECTRICAL CHARACTERISTICS FOR WDI3216

Part No.	Inductance (μ H)	Test Frequency (MHz)	RDC (Ω) Max	IDC (mA) Max
WDI3216-1R0 □	1.0	1MHz	0.364	510
WDI3216-2R2 □	2.2	1MHz	0.533	430
WDI3216-4R7 □	4.7	1MHz	0.845	340
WDI3216-100 □	10	1MHz	1.690	230
WDI3216-220 □	22	1MHz	3.900	160
WDI3216-470 □	47	1MHz	10.400	100
WDI3216-101 □	100	1MHz	15.600	80

ELECTRICAL CHARACTERISTICS FOR WDI3225

Part No.	Inductance (μ H)	Test Frequency (MHz)	RDC (Ω) Max	IDC (mA) Max
WDI3225-1R0□	1.0	1MHz	0.500	440
WDI3225-1R5□	1.5	1MHz	0.600	400
WDI3225-2R2□	2.2	1MHz	0.800	370
WDI3225-3R3□	3.3	1MHz	1.000	300
WDI3225-4R7□	4.7	1MHz	1.200	270
WDI3225-5R6□	5.6	1MHz	1.300	250
WDI3225-6R8□	6.8	1MHz	1.500	240
WDI3225-8R2□	8.2	1MHz	1.600	220
WDI3225-100□	10	1MHz	1.800	190
WDI3225-120□	12	1MHz	2.000	180
WDI3225-150□	15	1MHz	2.200	170
WDI3225-180□	18	1MHz	2.500	160
WDI3225-220□	22	1MHz	2.800	150
WDI3225-270□	27	1MHz	3.100	120
WDI3225-330□	33	1MHz	3.500	110
WDI3225-470□	47	1MHz	4.300	100
WDI3225-560□	56	1MHz	4.900	90
WDI3225-680□	68	1MHz	5.500	85
WDI3225-820□	82	1MHz	6.200	80
WDI3225-101□	100	1MHz	7.000	75
WDI3225-121□	120	1MHz	8.000	70
WDI3225-151□	150	1MHz	9.300	70
WDI3225-181□	180	1MHz	10.200	60

CORE MASTER ENTERPRISE CO., LTD.



<http://www.coremaster.com.tw>

SMD POWER INDUCTORS / WDI TYPE

ELECTRICAL CHARACTERISTICS FOR WDI3225

Part No.	Inductance (μ H)	Test Frequency (MHz)	RDC (Ω) Max	IDC (mA) Max
WDI3225-221□	220	1MHz	11.800	60
WDI3225-271□	270	1MHz	12.500	60
WDI3225-331□	330	1MHz	13.000	60
WDI3225-391□	390	1MHz	22.000	50
WDI3225-471□	470	1MHz	25.000	45
WDI3225-561□	560	1MHz	28.000	40

ELECTRICAL CHARACTERISTICS FOR WDI4532

Part No.	Inductance (μ H)	Test Frequency (MHz)	RDC (Ω) Max	IDC (mA) Max
WDI4532-1R0□	1.0	1MHz	0.200	500
WDI4532-1R5□	1.5	1MHz	0.280	500
WDI4532-2R2□	2.2	1MHz	0.300	500
WDI4532-3R3□	3.3	1MHz	0.350	500
WDI4532-4R7□	4.7	1MHz	0.400	500
WDI4532-5R6□	5.6	1MHz	0.470	500
WDI4532-6R8□	6.8	1MHz	0.500	450
WDI4532-8R2□	8.2	1MHz	0.530	450
WDI4532-100□	10	1MHz	0.560	400
WDI4532-120□	12	1MHz	0.620	380
WDI4532-150□	15	1MHz	0.730	360
WDI4532-180□	18	1MHz	0.820	340
WDI4532-220□	22	1MHz	0.940	320
WDI4532-270□	27	1MHz	1.100	300
WDI4532-330□	33	1MHz	1.200	270
WDI4532-390□	39	1MHz	1.400	240
WDI4532-470□	47	1MHz	1.500	220
WDI4532-560□	56	1MHz	1.700	200
WDI4532-680□	68	1MHz	1.900	180
WDI4532-820□	82	1MHz	2.200	170
WDI4532-101□	100	1MHz	2.500	160
WDI4532-121□	120	1MHz	3.000	150
WDI4532-151□	150	1MHz	3.700	130
WDI4532-181□	180	1MHz	4.500	120

SMD POWER INDUCTORS / WDI TYPE

ELECTRICAL CHARACTERISTICS FOR WDI4532

Part No.	Inductance (uH)	Test Frequency (MHz)	RDC (Ω) Max	IDC (mA) Max
WDI4532-221□	220	1MHz	5.400	110
WDI4532-271□	270	1MHz	6.800	100
WDI4532-331□	330	1MHz	8.200	90
WDI4532-391□	390	1MHz	9.700	90
WDI4532-471□	470	1KHz	11.800	80
WDI4532-561□	560	1KHz	14.500	70
WDI4532-681□	680	1KHz	17.000	60
WDI4532-821□	820	1KHz	20.500	60
WDI4532-102□	1000	1KHz	25.000	50

ELECTRICAL CHARACTERISTICS FOR WDI5750

Part No.	Inductance (uH)	Test Frequency (MHz)	RDC (Ω)Max	IDC (A) Max
WDI 5750-1R0 □	1.0	1MHz	0.027	4.00
WDI 5750-1R5 □	1.5	1MHz	0.031	3.70
WDI 5750-2R2 □	2.2	1MHz	0.041	3.20
WDI 5750-3R3 □	3.3	1MHz	0.050	2.90
WDI 5750-4R7 □	4.7	1MHz	0.057	2.70
WDI 5750-6R8 □	6.8	1MHz	0.104	2.00
WDI 5750-100 □	10	1MHz	0.130	1.70
WDI 5750-150 □	15	1MHz	0.210	1.40
WDI 5750-220 □	22	1MHz	0.266	1.20
WDI 5750-330 □	33	1MHz	0.448	0.90
WDI 5750-470 □	47	1MHz	0.560	0.80
WDI 5750-680 □	68	1MHz	0.938	0.64
WDI 5750-101 □	100	100KHz	1.204	0.56
WDI 5750-151 □	150	100KHz	2.660	0.42
WDI 5750-221 □	220	100KHz	3.360	0.32
WDI 5750-331 □	330	100KHz	6.160	0.27
WDI 5750-471 □	470	100KHz	7.560	0.24
WDI 5750-681 □	680	100KHz	11.340	0.19
WDI 5750-102 □	1000	10KHz	14.420	0.15

Notes:

- 1) Test Equipment : HP4284A or WK3260B LCR Meter.
- 2) DCR limits @ 20°C. Test Equipment: CH502BC.



SURFACE MOUNT HIGH CURRENT POWER INDUCTORS /SMPI TYPE

FEATURES

- ◆ Performance low resistance · high current rating.
- ◆ Low loss realized with low RDC.
- ◆ Low core loss.



APPLICATIONS

- ◆ PDA / Notebook / Desktop, and server applications.
- ◆ DC/DC converters in distributed power systems.
- ◆ DC/DC converter for Field Programmable Gate Array(FPGA)

ORDERING CODE

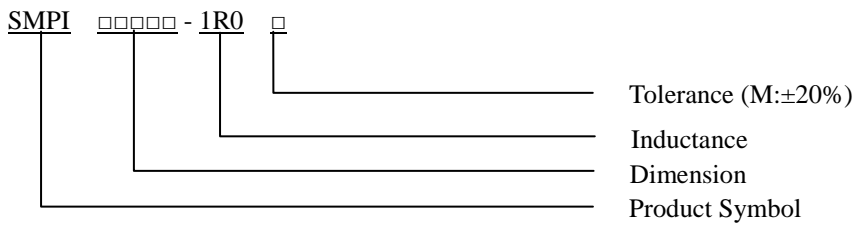

SHAPES

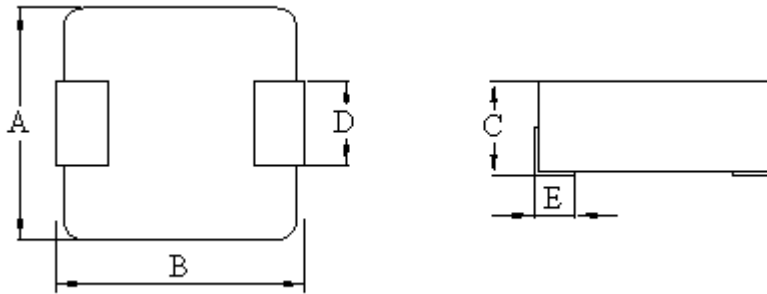

SURFACE MOUNT HIGH CURRENT POWER INDUCTORS /SMPI TYPE

DIMENSIONS (UNIT: mm)

Part No.	A	B	C (MAX)	D (REF)	E (REF)
SMPI 04020	4.0 ± 0.3	4.5 ± 0.4	2.0	1.8	1.0
SMPI 05015	5.2 ± 0.3	5.5 ± 0.4	1.5	2.0	1.0
SMPI 05030	5.2 ± 0.3	5.5 ± 0.4	3.0	2.0	1.0
SMPI 06020	6.6 ± 0.3	7.2 ± 0.5	2.0	3.0	1.6
SMPI 06030	6.6 ± 0.3	7.2 ± 0.5	3.0	3.0	1.6
SMPI 06050	6.6 ± 0.3	7.2 ± 0.5	5.0	3.0	1.6
SMPI 07050	7.2 ± 0.3	7.8 ± 0.5	5.0	3.0	1.6
SMPI 08030	8.0 ± 0.3	8.6 ± 0.6	3.0	3.0	1.8
SMPI 08040	8.0 ± 0.3	8.6 ± 0.6	4.0	3.0	1.8
SMPI 08050	8.0 ± 0.3	8.6 ± 0.6	5.0	3.0	1.8
SMPI 10040	10.0 ± 0.5	10.5 ± 1.0	4.0	3.0	2.2
SMPI 10045	10.0 ± 0.5	10.5 ± 1.0	4.5	3.0	2.2
SMPI 10050	10.0 ± 0.5	10.5 ± 1.0	5.0	3.0	2.2
SMPI 12040	12.8 ± 0.5	13.5 ± 1.0	4.0	3.8	2.5
SMPI 12050	12.8 ± 0.5	13.5 ± 1.0	5.0	3.8	2.5
SMPI 12065	12.8 ± 0.5	13.5 ± 1.0	6.5	3.8	2.5
SMPI 17070	17.2 (MAX)	18.0 ± 1.0	7.2	11.9	2.7
SMPI 22013	22.0 ± 0.3	22.5 ± 0.3	13	18.6	5.0

ELECTRICAL CHARACTERISTICS FOR SMPI 04020

Part No.	Inductance (uH) @ (0A)	Test Frequency	Heat Rating Current Irms(A)	Saturation Current Isat (A) drop30%	RDC (mΩ) MAX
SMPI04020-R10M	0.10	100KHz/1V	14	35	4.2
SMPI04020-R15M	0.15	100KHz/1V	11	28	4.5
SMPI04020-R22M	0.22	100KHz/1V	10	25	5.5
SMPI04020-R33M	0.33	100KHz/1V	9.0	17	9.8
SMPI04020-R47M	0.47	100KHz/1V	8.5	15	15
SMPI04020-R56M	0.56	100KHz/1V	8.0	13	15
SMPI04020-R68M	0.68	100KHz/1V	7.0	12	19
SMPI04020-1R0M	1.00	100KHz/1V	6.0	10	28
SMPI04020-1R2M	1.20	100KHz/1V	5.0	9.0	32
SMPI04020-1R5M	1.50	100KHz/1V	4.0	8.0	37
SMPI04020-2R2M	2.20	100KHz/1V	4.0	7.0	60
SMPI04020-3R3M	3.30	100KHz/1V	3.0	6.0	96
SMPI04020-4R7M	4.70	100KHz/1V	3.0	5.0	125
SMPI04020-5R6M	5.60	100KHz/1V	2.5	4.5	155
SMPI04020-6R8M	6.80	100KHz/1V	2.5	4.0	165
SMPI04020-8R2M	8.20	100KHz/1V	2.0	3.0	260
SMPI04020-100M	10	100KHz/1V	1.8	3.0	310

CORE MASTER ENTERPRISE CO., LTD.



<http://www.coremaster.com.tw>

SURFACE MOUNT HIGH CURRENT POWER INDUCTORS /SMPI TYPE
ELECTRICAL CHARACTERISTICS FOR SMPI 05015

Part No.	Inductance (uH) @(0A)	Test Frequency	Heat Rating Current Irms(A)	Saturation Current Isat (A) drop30%	RDC (mΩ) MAX
SMPI05015-R47M	0.47	100KHz/1V	9.0	12	13.5
SMPI05015-R68M	0.68	100KHz/1V	6.0	10	21.0
SMPI05015-1R0M	1.00	100KHz/1V	5.5	8.0	28.0
SMPI05015-2R2M	2.20	100KHz/1V	3.3	5.0	68.0
SMPI05015-3R3M	3.30	100KHz/1V	3.0	5.0	106
SMPI05015-4R7M	4.70	100KHz/1V	2.5	4.0	135
SMPI05015-5R6M	5.60	100KHz/1V	2.2	3.5	150
SMPI05015-6R8M	6.80	100KHz/1V	2.0	3.0	155
SMPI05015-100M	10	100KHz/1V	1.5	2.0	213

ELECTRICAL CHARACTERISTICS FOR SMPI 05030

Part No.	Inductance (uH) @(0A)	Test Frequency	Heat Rating Current Irms(A)	Saturation Current Isat (A) drop30%	RDC (mΩ) MAX
SMPI05030-R68M	0.68	100KHz/1V	9.0	12	11
SMPI05030-1R0M	1.00	100KHz/1V	8.0	10	13
SMPI05030-1R5M	1.50	100KHz/1V	6.0	9	18
SMPI05030-2R2M	2.20	100KHz/1V	5.5	8	30
SMPI05030-3R3M	3.30	100KHz/1V	5.0	7	38
SMPI05030-4R7M	4.70	100KHz/1V	4.0	6	62
SMPI05030-6R8M	6.80	100KHz/1V	3.0	5	90
SMPI05030-100M	10	100KHz/1V	2.0	3	115

ELECTRICAL CHARACTERISTICS FOR SMPI 06020

Part No.	Inductance (uH) @(0A)	Test Frequency	Heat Rating Current Irms(A)	Saturation Current Isat (A) drop30%	RDC (mΩ) MAX
SMPI06020-R10M	0.10	100KHz/1V	15	30	2.8
SMPI06020-R22M	0.22	100KHz/1V	13	22	7.0
SMPI06020-R68M	0.68	100KHz/1V	9.0	12	13.5
SMPI06020-1R0M	1.00	100KHz/1V	8.0	10	19.0
SMPI06020-2R2M	2.20	100KHz/1V	5.0	8	35.0
SMPI06020-3R3M	3.30	100KHz/1V	4.5	7	70.0
SMPI06020-4R7M	4.70	100KHz/1V	3.5	6	73.0
SMPI06020-6R8M	6.80	100KHz/1V	2.5	4	122

SURFACE MOUNT HIGH CURRENT POWER INDUCTORS /SMPI TYPE

ELECTRICAL CHARACTERISTICS FOR SMPI 06030

Part No.	Inductance (uH) @(0A)	Test Frequency	Heat Rating Current Irms(A)	Saturation Current Isat (A) drop30%	RDC (mΩ) MAX
SMPI06030-R10M	0.10	100KHz/1V	30	40.0	1.6
SMPI06030-R15M	0.15	100KHz/1V	26	35.0	2.1
SMPI06030-R22M	0.22	100KHz/1V	24	30.0	2.6
SMPI06030-R33M	0.33	100KHz/1V	21	27.0	3.5
SMPI06030-R47M	0.47	100KHz/1V	18	20.0	4.2
SMPI06030-R56M	0.56	100KHz/1V	16	18.0	4.2
SMPI06030-R68M	0.68	100KHz/1V	15	16.0	6.0
SMPI06030-R82M	0.82	100KHz/1V	14	15.5	8.5
SMPI06030-1R0M	1.00	100KHz/1V	11	15.0	11.0
SMPI06030-1R2M	1.20	100KHz/1V	10	14.0	12.5
SMPI06030-1R5M	1.50	100KHz/1V	9.0	13.0	12.5
SMPI06030-2R2M	2.20	100KHz/1V	8.0	10.0	19.0
SMPI06030-3R3M	3.30	100KHz/1V	6.0	9.0	27.6
SMPI06030-4R7M	4.70	100KHz/1V	5.0	8.0	45.0
SMPI06030-5R6M	5.60	100KHz/1V	4.5	7.0	48.0
SMPI06030-6R8M	6.80	100KHz/1V	4.0	6.5	63.0
SMPI06030-8R2M	8.20	100KHz/1V	3.5	6.0	63.0
SMPI06030-100M	10	100KHz/1V	3.0	5.0	95.0
SMPI06030-150M	15	100KHz/1V	2.8	4.0	128

CORE MASTER ENTERPRISE CO., LTD.

<http://www.coremaster.com.tw>



SURFACE MOUNT HIGH CURRENT POWER INDUCTORS /SMPI TYPE

ELECTRICAL CHARACTERISTICS FOR SMPI 06050

Part No.	Inductance (uH) @ (0A)	Test Frequency	Heat Rating Current Irms(A)	Saturation Current Isat (A) drop30%	RDC (mΩ) MAX
SMPI06050-R10M	0.10	100KHz/1V	35	50	1.6
SMPI06050-R22M	0.22	100KHz/1V	22	31	2.0
SMPI06050-R33M	0.33	100KHz/1V	23	28	2.8
SMPI06050-R47M	0.47	100KHz/1V	22	25	3.6
SMPI06050-R56M	0.56	100KHz/1V	19	22	4.5
SMPI06050-R68M	0.68	100KHz/1V	16	20	5.3
SMPI06050-R82M	0.82	100KHz/1V	14	19	6.0
SMPI06050-1R0M	1.00	100KHz/1V	13	18	6.8
SMPI06050-1R2M	1.20	100KHz/1V	12	16	6.8
SMPI06050-1R5M	1.50	100KHz/1V	11	14	8.0
SMPI06050-2R2M	2.20	100KHz/1V	10	13	12.5
SMPI06050-3R3M	3.30	100KHz/1V	9.0	11	15.5
SMPI06050-4R7M	4.70	100KHz/1V	7.5	10	20.0
SMPI06050-5R6M	5.60	100KHz/1V	6.5	8.0	23.0
SMPI06050-6R8M	6.80	100KHz/1V	5.5	7.5	28.0
SMPI06050-8R2M	8.20	100KHz/1V	5.0	7.5	41.0
SMPI06050-100M	10	100KHz/1V	4.5	7.0	41.0
SMPI06050-120M	12	100KHz/1V	4.2	6.5	53.0
SMPI06050-150M	15	100KHz/1V	4.0	6.0	62.0
SMPI06050-180M	18	100KHz/1V	3.5	5.5	88.0
SMPI06050-220M	22	100KHz/1V	3.0	5.0	93.0
SMPI06050-330M	33	100KHz/1V	2.5	4.0	145
SMPI06050-470M	47	100KHz/1V	2.0	3.0	208
SMPI06050-560M	56	100KHz/1V	1.8	2.5	248
SMPI06050-680M	68	100KHz/1V	1.5	2.0	310

CORE MASTER ENTERPRISE CO., LTD.



<http://www.coremaster.com.tw>

SURFACE MOUNT HIGH CURRENT POWER INDUCTORS /SMPI TYPE

ELECTRICAL CHARACTERISTICS FOR SMPI 07050

Part No.	Inductance (uH) @(0A)	Test Frequency	Heat Rating Current Irms(A)	Saturation Current Isat (A) drop30%	RDC (mΩ) MAX
SMPI07050-2R2M	2.2	100KHz/0.1V	9.0	14	12
SMPI07050-6R8M	6.8	100KHz/0.1V	5.5	8.0	30
SMPI07050-100M	10	100KHz/0.1V	4.8	7.0	65
SMPI07050-220M	22	100KHz/0.1V	3.0	5.0	140
SMPI07050-270M	27	100KHz/0.1V	3.0	4.5	182
SMPI07050-330M	33	100KHz/0.1V	2.0	4.0	237
SMPI07050-470M	47	100KHz/0.1V	2.0	3.5	247
SMPI07050-560M	56	100KHz/0.1V	1.8	3.0	310

ELECTRICAL CHARACTERISTICS FOR SMPI 08030

Part No.	Inductance (uH) @(0A)	Test Frequency	Heat Rating Current Irms(A)	Saturation Current Isat (A) drop30%	RDC (mΩ) MAX
SMPI08030-1R0M	1.0	100KHz/1V	11	16	6.5
SMPI08030-1R5M	1.5	100KHz/1V	10	14	7.2
SMPI08030-1R8M	1.8	100KHz/1V	9.5	13	16
SMPI08030-2R2M	2.2	100KHz/1V	9.0	12	17
SMPI08030-3R3M	3.3	100KHz/1V	8.0	10	19

ELECTRICAL CHARACTERISTICS FOR SMPI 08040

Part No.	Inductance (uH) @(0A)	Test Frequency	Heat Rating Current Irms(A)	Saturation Current Isat (A) drop30%	RDC (mΩ) MAX
SMPI08040-1R0M	1.0	100KHz/1V	13	18.0	6.5
SMPI08040-1R5M	1.5	100KHz/1V	12	16.0	8.0
SMPI08040-2R2M	2.2	100KHz/1V	10	15.0	9.0
SMPI08040-4R7M	4.7	100KHz/1V	8	11.5	19
SMPI08040-6R8M	6.8	100KHz/1V	6	10.0	27
SMPI08040-8R2M	8.2	100KHz/1V	5	8.0	48
SMPI08040-100M	10	100KHz/1V	5	7.0	48
SMPI08040-220M	22	100KHz/1V	4	6.0	118
SMPI08040-330M	33	100KHz/1V	3	4.0	168
SMPI08040-470M	47	100KHz/1V	2	3.5	200

CORE MASTER ENTERPRISE CO., LTD.



<http://www.coremaster.com.tw>

SURFACE MOUNT HIGH CURRENT POWER INDUCTORS /SMPI TYPE

ELECTRICAL CHARACTERISTICS FOR SMPI 08050

Part No.	Inductance (uH) @ (0A)	Test Frequency	Heat Rating Current Irms(A)	Saturation Current Isat (A) drop30%	RDC (mΩ) MAX
SMPI08050-R22M	0.22	100KHz/1V	20	35	1.2
SMPI08050-R68M	0.68	100KHz/1V	16	21	4.3
SMPI08050-R82M	0.82	100KHz/1V	15	20	4.8
SMPI08050-1R0M	1.00	100KHz/1V	14	19	5.8
SMPI08050-1R5M	1.50	100KHz/1V	13	18	6.5
SMPI08050-2R2M	2.20	100KHz/1V	11	17	9.0
SMPI08050-3R3M	3.30	100KHz/1V	10	15	12.5
SMPI08050-4R7M	4.70	100KHz/1V	9.0	13	19.0
SMPI08050-5R6M	5.60	100KHz/1V	8.0	12	23.5
SMPI08050-6R8M	6.80	100KHz/1V	7.0	11	25.0
SMPI08050-8R2M	8.20	100KHz/1V	6.0	10	36.0
SMPI08050-100M	10	100KHz/1V	5.5	9.0	37.0
SMPI08050-150M	15	100KHz/1V	5.0	8.0	60.0
SMPI08050-220M	22	100KHz/1V	4.0	7.0	79.0
SMPI08050-330M	33	100KHz/1V	3.5	5.0	142
SMPI08050-470M	47	100KHz/1V	3.0	4.0	165
SMPI08050-560M	56	100KHz/1V	2.0	3.5	176
SMPI08050-680M	68	100KHz/1V	1.8	2.5	206
SMPI08050-101M	100	100KHz/1V	1.5	2.0	285
SMPI08050-151M	150	100KHz/1V	1.2	1.8	430

CORE MASTER ENTERPRISE CO., LTD.



<http://www.coremaster.com.tw>

SURFACE MOUNT HIGH CURRENT POWER INDUCTORS /SMPI TYPE

ELECTRICAL CHARACTERISTICS FOR SMPI 10040

Part No.	Inductance (uH) @(0A)	Test Frequency	Heat Rating Current Irms(A)	Saturation Current Isat (A) drop30%	RDC (mΩ) MAX
SMPI10040-R15M	0.15	100KHz/1V	40	70	0.75
SMPI10040-R22M	0.22	100KHz/1V	30	50	1.0
SMPI10040-R33M	0.33	100KHz/1V	28	49	1.3
SMPI10040-R36M	0.36	100KHz/1V	25	48	1.3
SMPI10040-R45M	0.45	100KHz/1V	23	40	1.5
SMPI10040-R47M	0.47	100KHz/1V	21	35	1.5
SMPI10040-R56M	0.56	100KHz/1V	19	32	2.0
SMPI10040-R68M	0.68	100KHz/1V	18	25	2.0
SMPI10040-R82M	0.82	100KHz/1V	16	22	2.5
SMPI10040-1R0M	1.00	100KHz/1V	15	20	2.5
SMPI10040-1R5M	1.50	100KHz/1V	12	18	5.2
SMPI10040-2R2M	2.20	100KHz/1V	9.0	15	7.5
SMPI10040-3R3M	3.30	100KHz/1V	8.5	14	11.5
SMPI10040-4R7M	4.70	100KHz/1V	8.0	13	14.5
SMPI10040-5R6M	5.60	100KHz/1V	7.0	12	19.0
SMPI10040-6R8M	6.80	100KHz/1V	6.0	10	21.0
SMPI10040-8R2M	8.20	100KHz/1V	5.5	9.0	32.0
SMPI10040-100M	10	100KHz/1V	5.0	8.0	36.0
SMPI10040-150M	15	100KHz/1V	4.0	7.0	60.0
SMPI10040-220M	22	100KHz/1V	3.5	6.0	68.0
SMPI10040-330M	33	100KHz/1V	3.0	5.0	100
SMPI10040-470M	47	100KHz/1V	2.0	3.5	145

ELECTRICAL CHARACTERISTICS FOR SMPI 10045

Part No.	Inductance (uH) @(0A)	Test Frequency	Heat Rating Current Irms(A)	Saturation Current Isat (A) drop30%	RDC (mΩ) MAX
SMPI10045-100M	10	100KHz / 1V	6.0	9.0	27
SMPI10045-150M	15	100KHz / 1V	5.0	8.0	42
SMPI10045-220M	22	100KHz / 1V	4.0	7.0	63
SMPI10045-330M	33	100KHz / 1V	3.5	5.5	96
SMPI10045-470M	47	100KHz / 1V	3.0	5.0	147
SMPI10045-680M	68	100KHz / 1V	2.5	4.5	210
SMPI10045-820M	82	100KHz / 1V	2.0	4.0	245
SMPI10045-101M	100	100KHz / 1V	1.5	3.0	265

CORE MASTER ENTERPRISE CO., LTD.



<http://www.coremaster.com.tw>

SURFACE MOUNT HIGH CURRENT POWER INDUCTORS /SMPI TYPE

ELECTRICAL CHARACTERISTICS FOR SMPI 10050

Part No.	Inductance (uH) @ (0A)	Test Frequency	Heat Rating Current Irms(A)	Saturation Current Isat (A) drop30%	RDC (mΩ) MAX
SMPI10050-R36M	0.36	100KHz/1V	36	52	1.1
SMPI10050-R68M	0.68	100KHz/1V	20	35	1.9
SMPI10050-R82M	0.82	100KHz/1V	18	30	2.5
SMPI10050-1R0M	1.00	100KHz/1V	16	28	2.5
SMPI10050-1R2M	1.20	100KHz/1V	15	25	2.8
SMPI10050-1R5M	1.50	100KHz/1V	13	21	3.1
SMPI10050-2R2M	2.20	100KHz/1V	11	20	6.2
SMPI10050-3R3M	3.30	100KHz/1V	10	15	7
SMPI10050-4R7M	4.70	100KHz/1V	9.0	15	12
SMPI10050-5R6M	5.60	100KHz/1V	8.5	14	16
SMPI10050-6R8M	6.80	100KHz/1V	8.0	13	16
SMPI10050-8R2M	8.20	100KHz/1V	7.0	12	27
SMPI10050-100M	10	100KHz/1V	7.0	11	28
SMPI10050-150M	15	100KHz/1V	6.0	10.0	42
SMPI10050-220M	22	100KHz/1V	5.0	8.0	65
SMPI10050-330M	33	100KHz/1V	4.0	6.0	95
SMPI10050-470M	47	100KHz/1V	3.5	5.5	142
SMPI10050-680M	68	100KHz/1V	3.0	5.0	218
SMPI10050-820M	82	100KHz/1V	2.5	4.5	240
SMPI10050-101M	100	100KHz/1V	2.0	4.0	250
SMPI10050-151M	150	100KHz/1V	1.8	3.5	425
SMPI10050-181M	180	100KHz/1V	1.5	3.0	460
SMPI10050-201M	200	100KHz/1V	1.2	2.5	470

CORE MASTER ENTERPRISE CO., LTD.



<http://www.coremaster.com.tw>

SURFACE MOUNT HIGH CURRENT POWER INDUCTORS /SMPI TYPE

ELECTRICAL CHARACTERISTICS FOR SMPI 12040

Part No.	Inductance (uH) @(0A)	Test Frequency	Heat Rating Current Irms(A)	Saturation Current Isat (A) drop30%	RDC (mΩ) MAX
SMPI12040-R22M	0.22	100KHz/1V	32	50	0.9
SMPI12040-R33M	0.33	100KHz/1V	26	45	1.5
SMPI12040-R47M	0.47	100KHz/1V	23	40	1.6
SMPI12040-R68M	0.68	100KHz/1V	21	35	2.1
SMPI12040-1R0M	1.00	100KHz/1V	18	30	4.0
SMPI12040-1R5M	1.50	100KHz/1V	13	22	5.5
SMPI12040-2R2M	2.20	100KHz/1V	11	18	5.5
SMPI12040-3R3M	3.30	100KHz/1V	9	14	8.5
SMPI12040-4R7M	4.70	100KHz/1V	8	12	17.5
SMPI12040-6R8M	6.80	100KHz/1V	6	10	25
SMPI12040-8R2M	8.20	100KHz/1V	5	9	26
SMPI12040-100M	10	100KHz/1V	4	8	32

ELECTRICAL CHARACTERISTICS FOR SMPI 12050

Part No.	Inductance (uH) @(0A)	Test Frequency	Heat Rating Current Irms(A)	Saturation Current Isat (A) drop30%	RDC (mΩ) MAX
SMPI12050-R33M	0.33	100KHz/1V	40	60	1.0
SMPI12050-R36M	0.36	100KHz/1V	35	48	1.2
SMPI12050-R47M	0.47	100KHz/1V	25	45	1.2
SMPI12050-R56M	0.56	100KHz/1V	24	42	1.3
SMPI12050-R68M	0.68	100KHz/1V	23	38	1.3
SMPI12050-R82M	0.82	100KHz/1V	22	36	2.1
SMPI12050-1R0M	1.00	100KHz/1V	20	32	2.6
SMPI12050-1R2M	1.20	100KHz/1V	18	30	2.6
SMPI12050-1R5M	1.50	100KHz/1V	15	28	3.1
SMPI12050-2R2M	2.20	100KHz/1V	14	23	6.0
SMPI12050-3R3M	3.30	100KHz/1V	13	20	8.0
SMPI12050-4R7M	4.70	100KHz/1V	12	18	9.0
SMPI12050-5R6M	5.60	100KHz/1V	9.0	15	10.5
SMPI12050-6R8M	6.80	100KHz/1V	8.0	14	15.0
SMPI12050-8R2M	8.20	100KHz/1V	7.5	13	22.0
SMPI12050-100M	10	100KHz/1V	7.0	12	24.0
SMPI12050-150M	15	100KHz/1V	5.0	10	30.0
SMPI12050-220M	22	100KHz/1V	4.5	7	40.0
SMPI12050-330M	33	100KHz/1V	3.5	6	60.0
SMPI12050-470M	47	100KHz/1V	3.0	5	80.0
SMPI12050-680M	68	100KHz/1V	2.5	4	106

CORE MASTER ENTERPRISE CO., LTD.



<http://www.coremaster.com.tw>

SURFACE MOUNT HIGH CURRENT POWER INDUCTORS /SMPI TYPE

ELECTRICAL CHARACTERISTICS FOR SMPI 12065

Part No.	Inductance (uH) @ (0A)	Test Frequency	Heat Rating Current Irms(A)	Saturation Current Isat (A) drop30%	RDC (mΩ) MAX
SMPI12065-R47M	0.47	100KHz/1V	36	50	1.1
SMPI12065-1R0M	1.00	100KHz/1V	25	36	1.8
SMPI12065-1R2M	1.20	100KHz/1V	22	34	2.6
SMPI12065-1R5M	1.50	100KHz/1V	20	32	3.3
SMPI12065-2R2M	2.20	100KHz/1V	18	26	4.5
SMPI12065-3R3M	3.30	100KHz/1V	16	24	6.5
SMPI12065-4R7M	4.70	100KHz/1V	14	22	8.5
SMPI12065-5R6M	5.60	100KHz/1V	12	20	10.5
SMPI12065-6R8M	6.80	100KHz/1V	11	18	10.5
SMPI12065-8R2M	8.20	100KHz/1V	10	16	12.5
SMPI12065-100M	10	100KHz/1V	9.0	14	13.5
SMPI12065-150M	15	100KHz/1V	7.0	13	21.0
SMPI12065-220M	22	100KHz/1V	6.5	11	38.0
SMPI12065-330M	33	100KHz/1V	6.0	9.0	57.0
SMPI12065-470M	47	100KHz/1V	5.0	7.0	68.0
SMPI12065-560M	56	100KHz/1V	4.5	6.5	95.0
SMPI12065-680M	68	100KHz/1V	4.0	5.0	95.0
SMPI12065-101M	100	100KHz/1V	3.5	4.0	110
SMPI12065-151M	150	100KHz/1V	3.0	3.5	280
SMPI12065-201M	200	100KHz/1V	2.5	3.0	290
SMPI12065-221M	220	100KHz/1V	2.0	2.8	290
SMPI12065-331M	330	100KHz/1V	1.5	2.5	485
SMPI12065-401M	400	100KHz/1V	1.3	2.0	700

CORE MASTER ENTERPRISE CO., LTD.



<http://www.coremaster.com.tw>

SURFACE MOUNT HIGH CURRENT POWER INDUCTORS /SMPI TYPE

ELECTRICAL CHARACTERISTICS FOR SMPI 17070

Part No.	Inductance (uH) @ (0A)	Test Frequency	Heat Rating Current Irms(A)	Saturation Current Isat (A) drop30%	RDC (mΩ) MAX
SMPI17070-1R0M	1.0	100KHz/1V	35	60	1.6
SMPI17070-1R5M	1.5	100KHz/1V	33	50	2.5
SMPI17070-2R2M	2.2	100KHz/1V	30	40	3.2
SMPI17070-3R3M	3.3	100KHz/1V	23	30	3.8
SMPI17070-4R7M	4.7	100KHz/1V	20	26	4.8
SMPI17070-5R6M	5.6	100KHz/1V	18	23	5.0
SMPI17070-6R8M	6.8	100KHz/1V	17	22	7.5
SMPI17070-8R2M	8.2	100KHz/1V	16	20	9.0
SMPI17070-100M	10	100KHz/1V	14	18	10
SMPI17070-150M	15	100KHz/1V	12	16	21
SMPI17070-220M	22	100KHz/1V	10	13	25
SMPI17070-330M	33	100KHz/1V	8.0	10	33
SMPI17070-470M	47	100KHz/1V	7.0	9.0	45
SMPI17070-680M	68	100KHz/1V	5.0	8.5	73
SMPI17070-820M	82	100KHz/1V	4.5	8.0	104
SMPI17070-101M	100	100KHz/1V	4.0	7.0	115
SMPI17070-121M	120	100KHz/1V	3.5	5.5	118
SMPI17070-151M	150	100KHz/1V	3.0	5.0	150
SMPI17070-221M	220	100KHz/1V	2.5	4.0	265
SMPI17070-351M	350	100KHz/1V	1.8	3.0	415

CORE MASTER ENTERPRISE CO., LTD.



<http://www.coremaster.com.tw>

SURFACE MOUNT HIGH CURRENT POWER INDUCTORS /SMPI TYPE

ELECTRICAL CHARACTERISTICS FOR SMPI 22013

Part No.	Inductance (uH) @(0A)	Test Frequency	Heat Rating Current Irms(A)	Saturation Current Isat (A) drop30%	RDC (mΩ) MAX
SMPI22013-1R0M	1.0	100KHz/1V	60	75	1.1
SMPI22013-1R5M	1.5	100KHz/1V	55	70	1.2
SMPI22013-2R2M	2.2	100KHz/1V	50	65	1.5
SMPI22013-3R3M	3.3	100KHz/1V	48	60	1.8
SMPI22013-4R7M	4.7	100KHz/1V	45	55	2.0
SMPI22013-5R6M	5.6	100KHz/1V	40	52	2.5
SMPI22013-6R8M	6.8	100KHz/1V	35	42	3.5
SMPI22013-100M	10	100KHz/1V	32	40	4.5
SMPI22013-150M	15	100KHz/1V	22	30	6.8
SMPI22013-220M	22	100KHz/1V	19	26	11.0
SMPI22013-330M	33	100KHz/1V	16	23	17.5
SMPI22013-470M	47	100KHz/1V	13	18	24.0
SMPI22013-560M	56	100KHz/1V	12	16	35.0
SMPI22013-680M	68	100KHz/1V	11	13	38.0
SMPI22013-750M	75	100KHz/1V	10	12	39.0
SMPI22013-820M	82	100KHz/1V	9.0	11	40.0
SMPI22013-101M	100	100KHz/1V	8.0	10	45.0
SMPI22013-151M	150	100KHz/1V	6.0	8.0	80.0
SMPI22013-201M	200	100KHz/1V	5.0	6.0	105
SMPI22013-221M	220	100KHz/1V	4.5	5.5	125
SMPI22013-401M	400	100KHz/1V	2.5	4.0	230

Notes:

- 1) You require another part number please contact with us.
- 2) Inductance Tolerance $\pm 20\%$; Frequency Test : 100KHz/1.0v
- 3) All test data is referenced to 25°C ambient.
- 4) Irms : DC current (A) that will cause an approximate ΔT of 40°C
- 5) Isat : DC current (A) that will cause L_o to drop approximately 30%
- 6) We can design according to customer's request.



CORE MASTER ENTERPRISE CO., LTD.

<http://www.coremaster.com.tw>

SURFACE MOUNT HIGH CURRENT POWER INDUCTORS / SER TYPE

FEATURES

- ◆ Perfect for high current.
- ◆ Extremely low RDC.
- ◆ Low voltage power supply applications.
- ◆ Custom design available.



APPLICATIONS

- ◆ Desktop/server applications.
- ◆ Battery Power equipment.
- ◆ DC/DC converters.
- ◆ Power supplier, etc.

ORDERING CODE

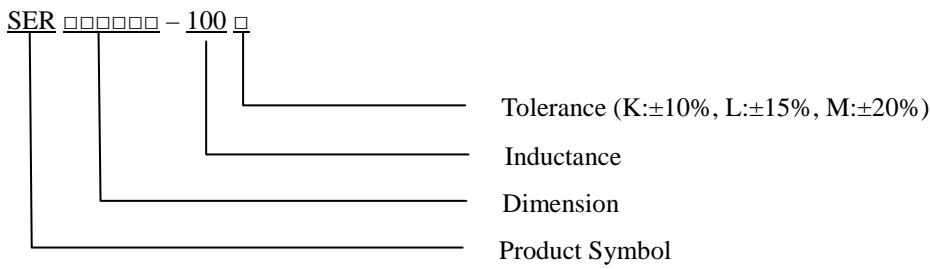

SHAPES

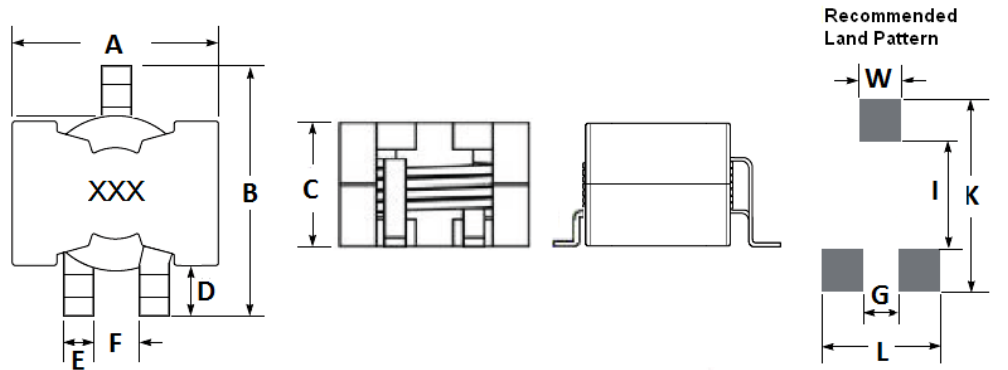

FIG. 1

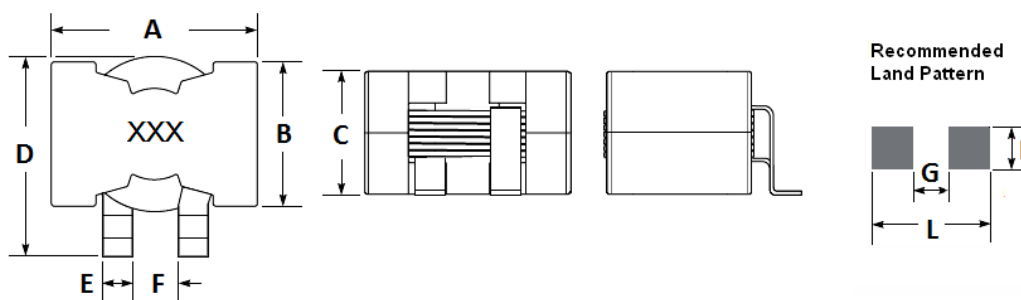

FIG. 2

CORE MASTER ENTERPRISE CO., LTD.



<http://www.coremaster.com.tw>

SURFACE MOUNT HIGH CURRENT POWER INDUCTORS / SER TYPE

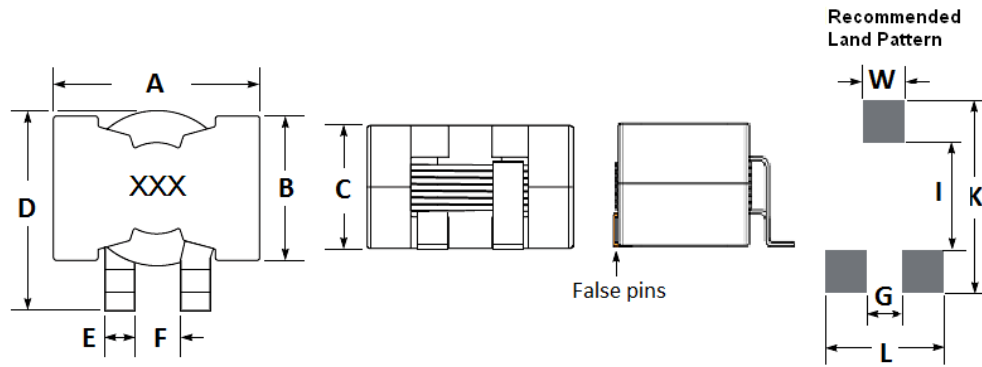

FIG. 3

DIMENSIONS UNIT: mm (inch)

Part No.	FIG.	A (MAX)	B (MAX)	C (MAX)	D (MAX)	E	F	G (REF)	I (REF)	K (REF)	L (REF)	W (REF)
SER2014T	1	21.8	24.5	14.5	4.0~7.5	2.2~3.8	4.0~7.0	4.0	13.0	23.0	14.0	5.0
SER2817H	2	27.9	19.3	17.0	28.5	3.8~4.0	6.6±0.5	4.8	5.6	-	15.6	-
SER2915HT	3	27.9	19.3	15.5	28.5	3.8~4.0	6.6±0.5	4.8	16.6	27.48	15.6	6.35
SER2918HT	3	27.9	19.3	17.5	28.5	3.8~4.0	6.6±0.5	4.8	16.6	27.48	15.6	6.35

ELECTRICAL CHARACTERISTICS FOR SER2014T

Part No.	Inductance (uH)	Test Frequency (MHz)	RDC (mΩ) Max	IDC (A) Max
SER2014T - R70□	0.7	500KHz/0.1V	0.92	75
SER2014T - 1R4□	1.4	500KHz/0.1V	1.19	60
SER2014T - 2R2□	2.2	500KHz/0.1V	1.65	52
SER2014T - 3R1□	3.1	500KHz/0.1V	2.30	45
SER2014T - 4R2□	4.2	500KHz/0.1V	3.35	38
SER2014T - 5R5□	5.5	500KHz/0.1V	4.40	33
SER2014T - 7R0□	7.0	500KHz/0.1V	6.17	30
SER2014T - 8R6□	8.6	500KHz/0.1V	7.91	25
SER2014T - 100□	10	500KHz/0.1V	8.75	23
SER2014T - 150□	15	500KHz/0.1V	9.57	21
SER2014T - 220□	22	500KHz/0.1V	11.71	15
SER2014T - 330□	33	500KHz/0.1V	12.54	11
SER2014T - 470□	47	500KHz/0.1V	13.42	8.5

CORE MASTER ENTERPRISE CO., LTD.



<http://www.coremaster.com.tw>

SURFACE MOUNT HIGH CURRENT POWER INDUCTORS / SER TYPE

ELECTRICAL CHARACTERISTICS FOR SER2817H

Part No.	Inductance (μ H)	Test Frequency (MHz)	RDC ($m\Omega$) Max	IDC (A) Max
SER2817H - 3R3□	3.3	500KHz/0.1V	2.8	92.5
SER2817H - 4R7□	4.7	500KHz/0.1V	2.8	61.2
SER2817H - 6R8□	6.8	500KHz/0.1V	2.8	45.0
SER2817H - 100□	10	500KHz/0.1V	2.8	31.2
SER2817H - 150□	15	500KHz/0.1V	2.8	21.2
SER2817H - 220□	22	500KHz/0.1V	2.8	14.0
SER2817H - 330□	33	500KHz/0.1V	2.8	8.7

ELECTRICAL CHARACTERISTICS FOR SER2915HT

Part No.	Inductance (μ H)	Test Frequency (MHz)	RDC ($m\Omega$) Max	IDC (A) Max
SER2915HT - 3R3□	3.3	500KHz/0.1V	1.75	66.9
SER2915HT - 4R7□	4.7	500KHz/0.1V	1.75	48.0
SER2915HT - 6R8□	6.8	500KHz/0.1V	1.75	34.5
SER2915HT - 100□	10	500KHz/0.1V	1.75	21.5
SER2915HT - 150□	15	500KHz/0.1V	1.75	14.0
SER2915HT - 220□	22	500KHz/0.1V	1.75	8.6
SER2915HT - 330□	33	500KHz/0.1V	1.75	5.1

ELECTRICAL CHARACTERISTICS FOR SER2918HT

Part No.	Inductance (μ H)	Test Frequency (MHz)	RDC ($m\Omega$) Max	IDC (A) Max
SER2918H - 3R3□	3.3	500KHz/0.1V	2.8	92.5
SER2918H - 4R7□	4.7	500KHz/0.1V	2.8	61.2
SER2918H - 6R8□	6.8	500KHz/0.1V	2.8	45.0
SER2918H - 100□	10	500KHz/0.1V	2.8	31.2
SER2918H - 150□	15	500KHz/0.1V	2.8	21.2
SER2918H - 220□	22	500KHz/0.1V	2.8	14.0
SER2918H - 330□	33	500KHz/0.1V	2.8	8.7

HIGH CURRENT POWER INDUCTORS / THT TYPE

FEATURES

- ◆ High current
- ◆ High energy storage and low DCR.



APPLICATIONS

- ◆ PDA / Notebook / Desktop, and server applications.
- ◆ DC/DC converters in distributed power systems.
- ◆ DC/DC converter for Field Programmable Gate Array(FPGA).

ORDERING CODE

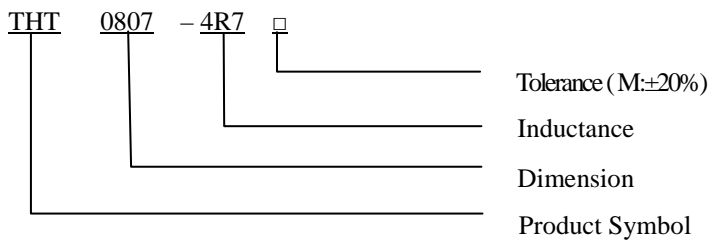

SHAPES

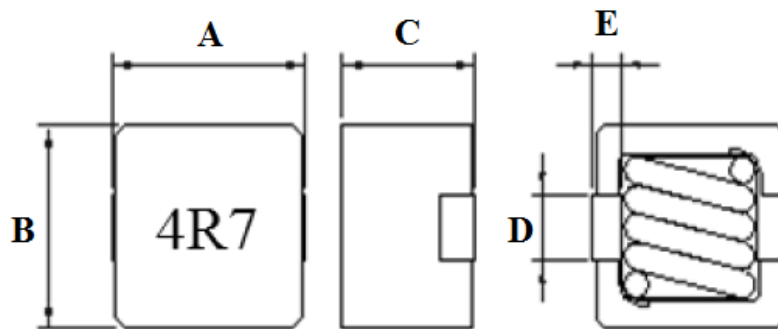

DIMENSIONS (UNIT: mm)

Part No.	A(Max)	B(Max)	C(Max)	D(Ref)	D(Ref)
THT 0807	8.4	8.8	7.5	2.3	1.5
THT 1009	10.4	11.3	9.8	3.0	1.6
THT 1210	11.8	12.5	10.0	3.5	2.0

HIGH CURRENT POWER INDUCTORS / THT TYPE

ELECTRICAL CHARACTERISTICS FOR THT 0807

Part No.	Inductance (uH)	Test Frequency	RDC (mΩ) MAX	IDC (A) MAX
THT0807-R30M	0.30	100KHz/0.1V	1.54	36.0
THT0807-R47M	0.47	100KHz/0.1V	1.89	32.0
THT0807-R56M	0.56	100KHz/0.1V	2.00	28.0
THT0807-R68M	0.68	100KHz/0.1V	2.10	23.5
THT0807-R82M	0.82	100KHz/0.1V	3.25	23.0
THT0807-1R0M	1.00	100KHz/0.1V	3.80	22.0
THT0807-1R5M	1.50	100KHz/0.1V	4.84	18.5
THT0807-2R2M	2.20	100KHz/0.1V	5.60	12.5
THT0807-3R3M	3.30	100KHz/0.1V	7.15	8.5
THT0807-4R7M	4.70	100KHz/0.1V	13.64	8.0
THT0807-6R8M	6.80	100KHz/0.1V	24.42	7.5
THT0807-100M	10.0	100KHz/0.1V	44.55	6.0

ELECTRICAL CHARACTERISTICS FOR THT 1009

Part No.	Inductance (uH)	Test Frequency	RDC (mΩ) MAX	IDC (A) MAX
THT1009-R22M	0.22	100KHz/0.1V	0.66	58.0
THT1009-R33M	0.33	100KHz/0.1V	0.70	50.0
THT1009-R47M	0.47	100KHz/0.1V	0.88	47.0
THT1009-R68M	0.68	100KHz/0.1V	1.49	34.0
THT1009-R82M	0.82	100KHz/0.1V	1.52	32.0
THT1009-1R0M	1.00	100KHz/0.1V	2.10	27.5
THT1009-1R5M	1.50	100KHz/0.1V	2.75	27.0
THT1009-2R2M	2.20	100KHz/0.1V	4.07	22.0
THT1009-3R3M	3.30	100KHz/0.1V	6.94	15.5
THT1009-4R7M	4.70	100KHz/0.1V	9.02	15.0
THT1009-6R8M	6.80	100KHz/0.1V	14.52	11.0
THT1009-8R2M	8.20	100KHz/0.1V	18.52	9.0
THT1009-100M	10.0	100KHz/0.1V	24.50	7.0

CORE MASTER ENTERPRISE CO., LTD.

<http://www.coremaster.com.tw>



HIGH CURRENT POWER INDUCTORS / THT TYPE

ELECTRICAL CHARACTERISTICS FOR THT 1210

Part No.	Inductance (uH)	Test Frequency	RDC (mΩ) MAX	IDC (A) MAX
THT1210-R22M	0.22	100KHz/0.1V	0.58	60.0
THT1210-R33M	0.33	100KHz/0.1V	0.62	55.0
THT1210-R47M	0.47	100KHz/0.1V	0.79	48.0
THT1210-R68M	0.68	100KHz/0.1V	0.85	38.0
THT1210-R82M	0.82	100KHz/0.1V	1.36	36.0
THT1210-1R0M	1.00	100KHz/0.1V	1.48	32.0
THT1210-1R5M	1.50	100KHz/0.1V	2.31	27.0
THT1210-2R2M	2.20	100KHz/0.1V	3.36	23.0
THT1210-3R3M	3.30	100KHz/0.1V	5.84	20.0
THT1210-4R7M	4.70	100KHz/0.1V	7.99	17.0
THT1210-6R8M	6.80	100KHz/0.1V	11.20	13.0
THT1210-8R2M	8.20	100KHz/0.1V	13.50	12.0
THT1210-100M	10.0	100KHz/0.1V	15.84	10.0

CORE MASTER ENTERPRISE CO., LTD.

<http://www.coremaster.com.tw>



HIGH CURRENT POWER INDUCTORS / SIC TYPE

FEATURES

- ◆ Clip Plated Type, Low Profile.
- ◆ High power, High saturation inductors.
- ◆ Ideal inductors for DC-DC conversion.
- ◆ Available on tape and reel for auto surface mounting.



APPLICATIONS

- ◆ Notebook / Desktop / server applications.
- ◆ Battery Power equipment.
- ◆ DC/DC converters.
- ◆ Power supplier, etc.

INDUCTANCE AND RATED CURRENT RANGES

- ◆ SIC10045L 0.36~4.3uH 18.0~5.0A
- ◆ SIC10056L 0.36~8.8uH 19.0~4.8A
- ◆ SIC10056H 0.15~3.0uH 19.0~4.9A
- ◆ SIC12057 1.5~10.0uH 14.0~5.0A
- ◆ SIC12057U 0.35~5.6uH 18.5~7.6A
- ◆ SIC13050H 0.3~6.0uH 18.5~6.5A

ORDERING CODE

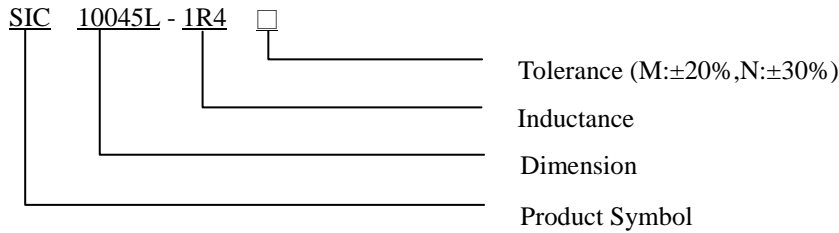

SHAPES

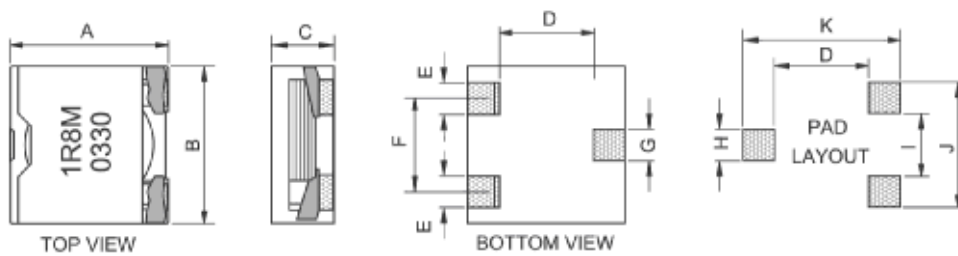

DIMENSIONS (UNIT: mm)

Part No.	A (Max)	B (Max)	C (Max)	D (Ref)	E (Ref)	F (Ref)	G (Ref)	H (Ref)	I (Ref)	J (Ref)	K (Ref)
SIC10045	10.4	10.4	4.5	6.7	2.6	5.5	1.4	2.0	2.5	8.5	11.0
SIC10056	10.4	10.4	5.6	6.7	2.6	5.5	1.4	2.0	2.5	8.5	11.0
SIC12057	12.9	12.9	5.7	8.2	2.6	7.0	2.5	3.0	4.0	10.0	13.5
SIC13050	13.9	13.9	5.0	9.6	2.6	7.2	2.5	2.6	4.4	10.0	15.0

CORE MASTER ENTERPRISE CO., LTD.



<http://www.coremaster.com.tw>

HIGH CURRENT POWER INDUCTORS / SIC TYPE

Part No.	Inductance (uH)	RDC (mΩ) Max			IDC (A) Max		
		10045L	10056L	10056H	10045L	10056L	10056H
R15	0.15			1.7			19.0
R22	0.22						
R30	0.30			2.4			17.7
R36	0.36	2.2	1.7		18.0	19.0	
R45	0.45						
R50	0.50			4.1			13.0
R80	0.80	3.7	2.4	5.3	13.4	16.0	11.2
1R2	1.20			7.5			9.0
1R3	1.30						
1R4	1.40	5.9	4.1		10.2	12.0	
1R5	1.50			10.5			7.8
1R8	1.80						
2R0	2.00			12.4			7.4
2R2	2.20	11.8	5.3		7.3	9.6	
2R5	2.50						
3R0	3.00			23.8			4.9
3R2	3.20	18.6	7.5		5.4	7.8	
4R0	4.00						
4R3	4.30	21.8	10.5		5.0	6.8	
5R0	5.00						
5R7	5.70		12.4			5.8	
7R2	7.20		18.0			5.3	
8R8	8.80		23.8			4.8	

★ Test Frequency: 100KHz / 1V

HIGH CURRENT POWER INDUCTORS / SIC TYPE

Part No.	Inductance (μ H)	RDC ($m\Omega$) Max			IDC (A) Max		
		12057	12057U	13050H	12057	12057U	13050H
R30	0.30			1.9			18.5
R35	0.35		1.8			18.5	
R40	0.40						
R66	0.66			2.5			17.0
R80	0.80		2.5			16.5	
R90	0.90						
1R0	1.00						
1R2	1.20			3.7			15.0
1R4	1.40		3.4			15.5	
1R5	1.50	2.5			14.0		
1R6	1.60						
1R8	1.80			6.6			10.5
2R2	2.20		5.4			12.5	
2R5	2.50	3.4			10.0		
2R7	2.70			10.8			8.0
2R8	2.80						
3R2	3.20		8.0			9.9	
3R6	3.60			12.0			7.5
4R0	4.00	8.0			8.3		
4R3	4.30		11.4			8.2	
4R8	4.80			16.3			7.0
5R6	5.60		13.5			7.6	
6R0	6.00	8.0		18.4	6.7		6.5
6R4	6.40						
7R2	7.20						
8R0	8.00						
8R2	8.20	11.4			5.8		
100	10.00	13.5			5.0		

★ Test Frequency: 100KHz / 1V



CORE MASTER ENTERPRISE CO., LTD.

<http://www.coremaster.com.tw>

SMD MULTILAYER FERRITE CHIP BEADS / CB TYPE

FEATURES

- ◆ Suitable for flow and reflow soldering
- ◆ Impedance over a broad frequency range
- ◆ Standard type used to suppress lower-frequency, lower current signals



APPLICATIONS

- ◆ Consumer electronic products
- ◆ Computer and peripheral products
- ◆ I/O ports, DC power lines and Signal lines

ORDERING CODE

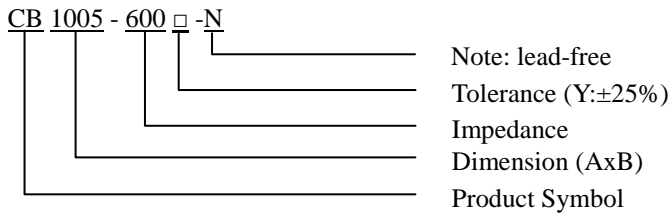

SHAPE

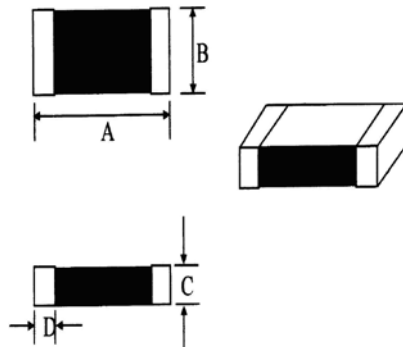

DIMENSIONS UNIT: mm (inch)

Part No.	A	B	C	D
CB 0603 (0201)	0.6 ± 0.03	0.3 ± 0.03	0.3 ± 0.03	0.10 ~ 0.20
CB 1005 (0402)	1.0 ± 0.10	0.5 ± 0.1	0.5 ± 0.1	0.25 ± 0.15
CB 1608 (0603)	1.6 ± 0.20	0.8 ± 0.2	0.8 ± 0.2	0.30 ± 0.20
CB 2012 (0805)	2.0 ± 0.20	1.2 ± 0.2	0.9 ± 0.2	0.50 ± 0.30
CB 3216 (1206)	3.2 ± 0.20	1.6 ± 0.2	1.1 ± 0.2	0.50 ± 0.30
CB 4516 (1806)	4.5 ± 0.20	1.6 ± 0.2	1.6 ± 0.2	0.50 ± 0.30

SMD MULTILAYER FERRITE CHIP BEADS / CB TYPE

ELECTRICAL CHARACTERISTICS

Part No.	Impedance (Ω) At 100MHz	DCR (Ω) Max	IDC (mA) Max	Part No.	Impedance (Ω) At 100MHz	DCR (Ω) Max	IDC (mA) Max
CB0603-40□-N	40	0.30	300	CB2012-110□-N	11	0.15	600
CB0603-50□-N	50	0.30	300	CB2012-320□-N	32	0.15	400
CB0603-60□-N	60	0.35	300	CB2012-800□-N	80	0.15	300
CB0603-70□-N	70	0.35	300	CB2012-121□-N	120	0.25	300
CB0603-121□-N	120	0.45	200	CB2012-151□-N	150	0.25	300
CB0603-151□-N	150	0.50	200	CB2012-221□-N	220	0.30	200
CB0603-221□-N	220	0.75	200	CB2012-301□-N	300	0.30	200
CB0603-301□-N	300	0.90	150	CB2012-501□-N	500	0.30	200
CB1005-300□-N	30	0.30	500	CB2012-601□-N	600	0.35	200
CB1005-600□-N	60	0.40	200	CB2012-102□-N	1000	0.45	200
CB1005-121□-N	120	0.50	200	CB3216-310□-N	31	0.20	500
CB1005-221□-N	220	0.70	100	CB3216-600□-N	60	0.30	400
CB1005-301□-N	300	0.80	100	CB3216-900□-N	90	0.30	300
CB1005-451□-N	450	0.90	100	CB3216-151□-N	150	0.30	300
CB1005-601□-N	600	1.00	100	CB3216-301□-N	300	0.30	300
CB1005-102□-N	1000	1.50	50	CB3216-601□-N	600	0.30	200
CB1608-090□-N	9	0.20	500	CB3216-122□-N	1200 (at 50 MHz)	0.50	100
CB1608-300□-N	30	0.20	400	CB3216-152□-N	1500 (at 50 MHz)	0.50	100
CB1608-600□-N	60	0.20	300	CB3216-202□-N	2000 (at 30 MHz)	0.60	100
CB1608-800□-N	80	0.20	300	CB4516-600□-N	60	0.10	500
CB1608-121□-N	120	0.20	200	CB4516-151□-N	150	0.30	300
CB1608-221□-N	220	0.20	200				
CB1608-301□-N	300	0.35	200				
CB1608-451□-N	450	0.40	200				
CB1608-601□-N	600	0.45	200				
CB1608-102□-N	1000	0.60	100				

CORE MASTER ENTERPRISE CO., LTD.



<http://www.coremaster.com.tw>

LARGE CURRENT MULTILAYER CHIP BEADS / LCB TYPE

FEATURES

- ◆ Low DCR, small package
- ◆ High current handling capacity
- ◆ Nickel barrier terminations provide excellent solder heat resistance
- ◆ Suitable for flow and reflow soldering and high current applications



APPLICATIONS

- ◆ Electronic games
- ◆ Personal computers Hard disk drivers and other electronic equipments

ORDERING CODE

LCB 2012 - 121 □-N

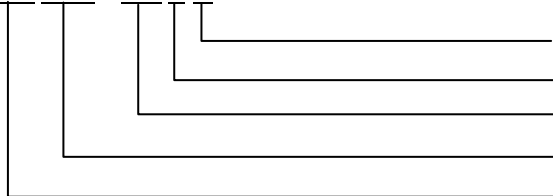

Note: lead-free
Tolerance (Y:±25%)
Inductance
Dimension (AxB)
Product Symbol

SHAPE

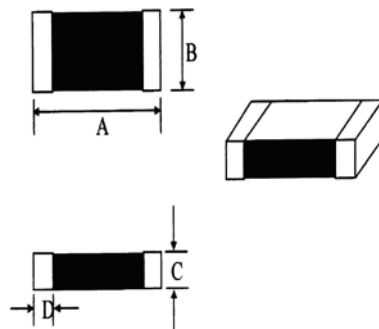

DIMENSIONS UNIT: mm (inch)

Part No.	A	B	C	D
LCB 1608 (0603)	1.6 ± 0.2	0.8 ± 0.2	0.8 ± 0.2	0.3 ± 0.2
LCB 2012 (0805)	2.0 ± 0.2	1.2 ± 0.2	0.9 ± 0.2	0.5 ± 0.3
LCB 3216 (1206)	3.2 ± 0.2	1.6 ± 0.2	1.1 ± 0.2	0.5 ± 0.3
LCB 4516 (1806)	4.5 ± 0.2	1.6 ± 0.2	1.6 ± 0.2	0.5 ± 0.3
LCB 4532 (1812)	4.5 ± 0.2	3.2 ± 0.2	1.5 ± 0.2	0.5 ± 0.3

CORE MASTER ENTERPRISE CO., LTD.

<http://www.coremaster.com.tw>



LARGE CURRENT MULTILAYER CHIP BEADS / LCB TYPE

ELECTRICAL CHARACTERISTICS

Part No.	Impedance (Ω) AT 100MHz	DC Resistance (Ω) Max	Rated Current (A) Max
LCB 1608-100 □-N	10	0.030	4.0
LCB 1608-300 □-N	30	0.050	3.0
LCB 1608-600 □-N	60	0.050	3.0
LCB 1608-121 □-N	120	0.100	2.0
LCB 1608-221 □-N	220	0.150	1.5
LCB 1608-301 □-N	300	0.150	1.5
LCB 1608-601 □-N	600	0.300	1.0
LCB 2012-110 □-N	11	0.010	6.0
LCB 2012-170 □-N	17	0.010	6.0
LCB 2012-220 □-N	22	0.010	6.0
LCB 2012-300 □-N	30	0.030	4.0
LCB 2012-600 □-N	60	0.050	3.0
LCB 2012-121 □-N	120	0.080	2.5
LCB 2012-221 □-N	220	0.100	2.0
LCB 2012-301 □-N	300	0.100	2.0
LCB 2012-601 □-N	600	0.300	1.0
LCB 2012-102 □-N	1000	0.300	1.0
LCB 3216-310 □-N	31	0.010	6.0
LCB 3216-500 □-N	50	0.025	3.0
LCB 3216-121 □-N	120	0.080	2.5
LCB 3216-301 □-N	300	0.080	2.5
LCB 3216-601 □-N	600	0.100	2.0
LCB 3216-102 □-N	1000	0.200	1.5
LCB 4516-600 □-N	60	0.010	6.0
LCB 4516-750 □-N	75	0.050	3.0
LCB 4516-800 □-N	80	0.050	3.0
LCB 4516-471 □-N	470	0.090	2.0
LCB 4532-700 □-N	70	0.030	6.0
LCB 4532-121 □-N	120	0.050	3.0

CORE MASTER ENTERPRISE CO., LTD.



<http://www.coremaster.com.tw>

MULTILAYER CHIP INDUCTORS / CL TYPE

FEATURES

- ◆ High mounting density of compact circuit due to crosstalk elimination that results from a closed magnetic flux in a ferrite material
- ◆ Suitable for flow and re-flow soldering
- ◆ Available in 3 sizes



APPLICATIONS

- ◆ Personal computers, HDDs, or other various electronic appliances.
- ◆ Any general circuit of portable equipment in which compact size and high mounting densities are required.

ORDERING CODE

CL 1608 - 8R2 □ - N

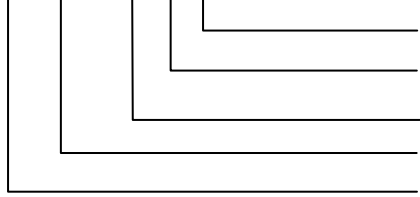

Note: lead-free
Tolerance (K:±10%, M:±20%)
Inductance
Dimension (AxB)
Product Symbol

SHAPES

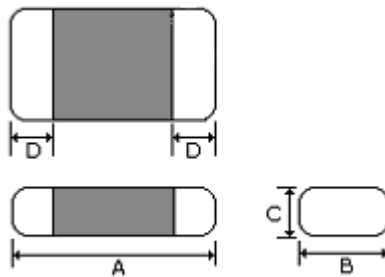

DIMENSIONS UNIT: mm (inch)

Part No.	Dimensions			
	A	B	C	D
CL 1608 (0603)	1.60 ± 0.15	0.80 ± 0.15	0.80 ± 0.15	0.30 ± 0.20
CL 2012 (0805)	2.00 ± 0.20	1.25 ± 0.20	0.85 ± 0.20	0.50 ± 0.30
CL 3216 (1206)	3.20 ± 0.20	1.60 ± 0.20	1.10 ± 0.30	0.50 ± 0.30



CORE MASTER ENTERPRISE CO., LTD.

<http://www.coremaster.com.tw>

MULTILAYER CHIP INDUCTORS / CL TYPE

ELECTRICAL CHARACTERISTICS FOR CL1608

Part No.	Inductance (uH)	Test Freq. (MHz) 60mV	Q Min	Self Resonant FREQ. (MHz) Min	DC Resistance (Ω) Max	Rated Current (mA) Max
CL 1608-47N □-N	0.047	50	10	260	0.30	50
CL 1608-68N □-N	0.068	50	10	250	0.30	50
CL 1608-82N □-N	0.082	50	10	245	0.30	50
CL 1608-R10 □-N	0.10	25	15	240	0.50	50
CL 1608-R12 □-N	0.12	25	15	205	0.50	50
CL 1608-R15 □-N	0.15	25	15	180	0.60	50
CL 1608-R18 □-N	0.18	25	15	165	0.60	50
CL 1608-R22 □-N	0.22	25	15	150	0.80	50
CL 1608-R27 □-N	0.27	25	15	136	0.80	50
CL 1608-R33 □-N	0.33	25	15	125	0.85	35
CL 1608-R39 □-N	0.39	25	15	110	1.00	35
CL 1608-R47 □-N	0.47	25	15	105	1.35	35
CL 1608-R56 □-N	0.56	25	15	95	1.50	35
CL 1608-R68 □-N	0.68	25	15	85	1.70	35
CL 1608-R82 □-N	0.82	25	15	75	2.10	35
CL 1608-1R0 □-N	1.0	10	30	65	0.60	25
CL 1608-1R2 □-N	1.2	10	30	60	0.80	25
CL 1608-1R5 □-N	1.5	10	30	55	0.80	25
CL 1608-1R8 □-N	1.8	10	30	50	0.95	25
CL 1608-2R2 □-N	2.2	10	30	45	1.15	15
CL 1608-2R7 □-N	2.7	10	30	40	1.35	15
CL 1608-3R3 □-N	3.3	10	30	38	1.55	15
CL 1608-3R9 □-N	3.9	10	30	36	1.70	15
CL 1608-4R7 □-N	4.7	10	30	33	2.10	15
CL 1608-5R6 □-N	5.6	4	30	22	1.55	15
CL 1608-6R8 □-N	6.8	4	30	20	1.70	15
CL 1608-8R2 □-N	8.2	4	30	18	2.10	15
CL 1608-100 □-N	10	2	30	17	2.55	15

CORE MASTER ENTERPRISE CO., LTD.



<http://www.coremaster.com.tw>

MULTILAYER CHIP INDUCTORS / CL TYPE

ELECTRICAL CHARACTERISTICS FOR CL2012

Part No.	Inductance (uH)	Test Freq. (MHz) 60mV	Q Min	Self Resonant FREQ. (MHz) Min	DC Resistance (Ω) Max	Rated Current (mA) Max
CL 2012-47N □-N	0.047	50	15	320	0.20	300
CL 2012-68N □-N	0.068	50	15	280	0.20	300
CL 2012-82N □-N	0.082	50	15	255	0.20	300
CL 2012-R10 □-N	0.10	25	20	235	0.30	250
CL 2012-R12 □-N	0.12	25	20	220	0.30	250
CL 2012-R15 □-N	0.15	25	20	200	0.40	250
CL 2012-R18 □-N	0.18	25	20	185	0.40	250
CL 2012-R22 □-N	0.22	25	20	170	0.50	250
CL 2012-R27 □-N	0.27	25	20	150	0.50	250
CL 2012-R33 □-N	0.33	25	20	145	0.55	250
CL 2012-R39 □-N	0.39	25	25	135	0.65	200
CL 2012-R47 □-N	0.47	25	25	125	0.65	200
CL 2012-R56 □-N	0.56	25	25	115	0.75	150
CL 2012-R68 □-N	0.68	25	25	105	0.80	150
CL 2012-R82 □-N	0.82	25	25	100	1.00	150
CL 2012-1R0 □-N	1.0	10	45	75	0.40	50
CL 2012-1R2 □-N	1.2	10	45	65	0.50	50
CL 2012-1R5 □-N	1.5	10	45	60	0.50	50
CL 2012-1R8 □-N	1.8	10	45	55	0.60	50
CL 2012-2R2 □-N	2.2	10	45	50	0.65	30
CL 2012-2R7 □-N	2.7	10	45	45	0.75	30
CL 2012-3R3 □-N	3.3	10	45	41	0.80	30
CL 2012-3R9 □-N	3.9	10	45	38	0.90	30
CL 2012-4R7 □-N	4.7	10	45	35	1.00	30
CL 2012-5R6 □-N	5.6	4	45	32	0.90	15
CL 2012-6R8 □-N	6.8	4	45	29	1.00	15
CL 2012-8R2 □-N	8.2	4	45	26	1.10	15
CL 2012-100 □-N	10	2	45	24	1.15	15

CORE MASTER ENTERPRISE CO., LTD.



<http://www.coremaster.com.tw>

MULTILAYER CHIP INDUCTORS / CL TYPE

ELECTRICAL CHARACTERISTICS FOR CL3216

Part No.	Inductance (uH)	Test Freq. (MHz)	Q Min	Self Resonant FREQ. (MHz) Min	DC Resistance (Ω) Max	Rated Current (mA) Max
CL 3216-47N □-N	0.047	50	20	320	0.15	300
CL 3216-68N □-N	0.068	50	20	280	0.25	300
CL 3216-82N □-N	0.082	50	20	260	0.25	300
CL 3216-R10 □-N	0.10	25	25	235	0.25	250
CL 3216-R12 □-N	0.12	25	25	220	0.30	250
CL 3216-R15 □-N	0.15	25	25	200	0.30	250
CL 3216-R18 □-N	0.18	25	25	185	0.40	250
CL 3216-R22 □-N	0.22	25	25	170	0.40	250
CL 3216-R27 □-N	0.27	25	25	150	0.50	250
CL 3216-R33 □-N	0.33	25	25	145	0.50	250
CL 3216-R39 □-N	0.39	25	25	135	0.60	250
CL 3216-R47 □-N	0.47	25	25	125	0.60	200
CL 3216-R56 □-N	0.56	25	25	115	0.70	200
CL 3216-R68 □-N	0.68	25	25	105	0.80	150
CL 3216-R82 □-N	0.82	25	25	100	0.90	150
CL 3216-1R0 □-N	1.0	10	45	75	0.40	100
CL 3216-1R2 □-N	1.2	10	45	65	0.50	100
CL 3216-1R5 □-N	1.5	10	45	60	0.50	50
CL 3216-1R8 □-N	1.8	10	45	55	0.50	50
CL 3216-2R2 □-N	2.2	10	45	50	0.60	50
CL 3216-2R7 □-N	2.7	10	45	45	0.60	50
CL 3216-3R3 □-N	3.3	10	45	41	0.70	50
CL 3216-3R9 □-N	3.9	10	45	38	0.80	50
CL 3216-4R7 □-N	4.7	10	45	35	0.90	50
CL 3216-5R6 □-N	5.6	4	50	32	0.70	25
CL 3216-6R8 □-N	6.8	4	50	29	0.80	25
CL 3216-8R2 □-N	8.2	4	50	26	0.90	25
CL 3216-100 □-N	10	4	50	24	1.00	25

CORE MASTER ENTERPRISE CO., LTD.



<http://www.coremaster.com.tw>

MULTILAYER HIGH CURRENT CHIP INDUCTORS / CL(C) TYPE

FEATURES

- ◆ High mounting density of compact circuit due to crosstalk elimination that results from a closed magnetic flux in a ferrite material
- ◆ Suitable for flow and re-flow soldering
- ◆ Available in 3 sizes



APPLICATIONS

- ◆ Personal computers, HDDs, or other various electronic appliances.
- ◆ Any general circuit of portable equipment in which compact size and high mounting densities are required.

ORDERING CODE

CL 2012C 1R0 □- N

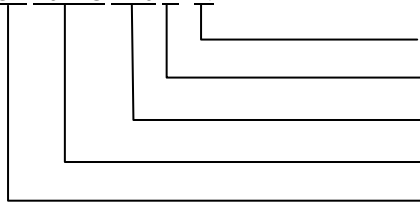

Note: lead-free
Tolerance (K:±10%, M:±20%)
Inductance
Dimension (AxB)
Product Symbol

SHAPES

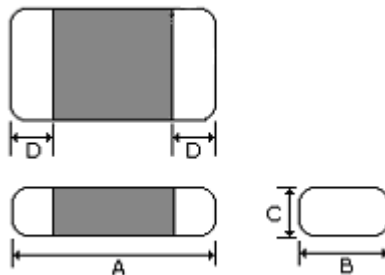

DIMENSIONS UNIT: mm (inch)

Part No.	Dimensions			
	A	B	C	D
CL 2012C (0805)	2.00 ± 0.20	1.25 ± 0.20	1.0 (Max)	0.7 (Max)
CL 2016C (0806)	2.00 ± 0.20	1.60 ± 0.20	1.0 (Max)	0.7 (Max)
CL 2520C (1008)	2.50 ± 0.20	2.00 ± 0.20	1.0 (Max)	0.8 (Max)

MULTILAYER HIGH CURRENT CHIP INDUCTORS / CL(C) TYPE

ELECTRICAL CHARACTERISTICS FOR CL2012C

Part No.	Inductance (uH)	Test Freq. (MHz)	Self Resonant FREQ. (MHz) Min	DC Resistance (Ω) Max	Rated Current (mA) Max
CL2012C-R47M-N	0.47	1MHz / 250mV	100	0.125	1100
CL2012C-R68M-N	0.68	1MHz / 250mV	100	0.150	1000
CL2012C-R82M-N	0.82	1MHz / 250mV	90	0.175	900
CL2012C-1R0M-N	1.00	1MHz / 250mV	90	0.200	800
CL2012C-1R2M-N	1.20	1MHz / 250mV	80	0.200	800
CL2012C-1R5M-N	1.50	1MHz / 250mV	70	0.275	700
CL2012C-1R8M-N	1.80	1MHz / 250mV	60	0.275	700
CL2012C-2R2M-N	2.20	1MHz / 250mV	50	0.313	600
CL2012C-3R3M-N	3.30	1MHz / 250mV	40	0.338	500
CL2012C-4R7M-N	4.70	1MHz / 250mV	30	0.375	500

ELECTRICAL CHARACTERISTICS FOR CL2016C

Part No.	Inductance (uH)	Test Freq. (MHz)	Self Resonant FREQ. (MHz) Min	DC Resistance (Ω) Max	Rated Current (mA) Max
CL2016C -R47M-N	0.47	1MHz / 250mV	100	0.182	1500
CL2016C -R68M-N	0.68	1MHz / 250mV	90	0.195	1500
CL2016C -R82M-N	0.82	1MHz / 250mV	80	0.208	1500
CL2016C -1R0M-N	1.00	1MHz / 250mV	60	0.208	1400
CL2016C -1R2M-N	1.20	1MHz / 250mV	60	0.208	1400
CL2016C -1R5M-N	1.50	1MHz / 250mV	50	0.260	1200
CL2016C -1R8M-N	1.80	1MHz / 250mV	50	0.260	1200
CL2016C -2R2M-N	2.20	1MHz / 250mV	40	0.286	1200
CL2016C -3R3M-N	3.30	1MHz / 250mV	30	0.312	1100
CL2016C -3R9M-N	3.90	1MHz / 250mV	30	0.364	1100
CL2016C -4R7M-N	4.70	1MHz / 250mV	20	0.390	1100

CORE MASTER ENTERPRISE CO., LTD.



<http://www.coremaster.com.tw>

MULTILAYER HIGH CURRENT CHIP INDUCTORS / CL(C) TYPE

ELECTRICAL CHARACTERISTICS FOR CL2520C

Part No.	Inductance (uH)	Test Freq. (MHz)	Self Resonant FREQ. (MHz) Min	DC Resistance (Ω) Max	Rated Current (mA) Max
CL2520C-R47M-N	0.47	1MHz / 250mV	100	0.088	1800
CL2520C-R68M-N	0.68	1MHz / 250mV	90	0.113	1700
CL2520C-R82M-N	0.82	1MHz / 250mV	80	0.125	1700
CL2520C-1R0M-N	1.00	1MHz / 250mV	60	0.138	1600
CL2520C-1R2M-N	1.20	1MHz / 250mV	60	0.138	1600
CL2520C-1R5M-N	1.50	1MHz / 250mV	50	0.163	1500
CL2520C-1R8M-N	1.80	1MHz / 250mV	50	0.163	1500
CL2520C-2R2M-N	2.20	1MHz / 250mV	40	0.213	1300
CL2520C-3R3M-N	3.30	1MHz / 250mV	30	0.225	1200
CL2520C-4R7M-N	4.70	1MHz / 250mV	25	0.250	1100
CL2520C-6R8M-N	6.80	1MHz / 250mV	25	0.260	1000

CORE MASTER ENTERPRISE CO., LTD.

<http://www.coremaster.com.tw>



MULTILAYER HIGH FREQUENCY CHIP INDUCTORS / HCL TYPE

FEATURES

- ◆ Cost Effective
- ◆ Small size of 0603/ 1005/1608/2012 is suitable for small portable equipment.
- ◆ Supports operating frequency up to 6GHz with nominal inductance values from 1.0nH to 680nH.
- ◆ Excellent Q factor and SRF characteristics.



APPLICATIONS

- ◆ Information technology equipments, computers, telecommunications, radar detectors, automotive electronics, cellular phones, pagers, PDAs, keyless remote systems.
- ◆ Use in L-C filter configurations

ORDERING CODE (HIGH FREQUENCY)

HCL 1608 - 1N5 □ - N

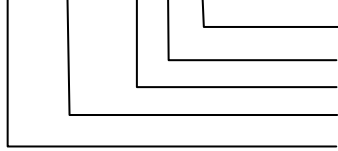

Note: lead-free
Tolerance (S:±0.3nH, J:±5%, K:±10%)
Inductance
Dimension (AxB)
Product Symbol

SHAPES

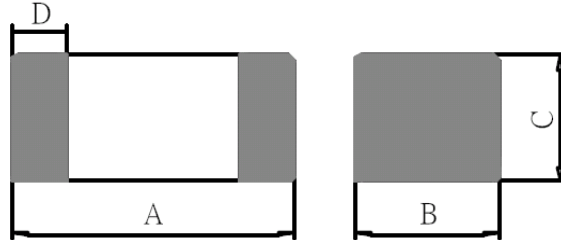

DIMENSIONS UNIT: mm (inch)

Part No.	A	B	C	D
HCL 0603 (0201)	0.60 ± 0.03	0.30 ± 0.03	0.30 ± 0.03	0.10 ~ 0.20
HCL 1005 (0402)	1.00 ± 0.10	0.50 ± 0.10	0.50 ± 0.10	0.25 ± 0.10
HCL 1608 (0603)	1.60 ± 0.15	0.80 ± 0.15	0.80 ± 0.15	0.30 ± 0.20
HCL 2012 (0805)	2.00 ± 0.20	1.25 ± 0.20	0.85 ± 0.20 1.25 ± 0.20	0.50 ± 0.30



CORE MASTER ENTERPRISE CO., LTD.

<http://www.coremaster.com.tw>

MULTILAYER HIGH FREQUENCY CHIP INDUCTORS / HCL TYPE

ELECTRICAL CHARACTERISTICS FOR HCL0603

Part No.	Inductance (nH)	Q Min	Test Freq. (MHz)	Self Resonant Freq. (GHz) Min	DC Resistance (Ω) Max	Rated Current (mA) Max
HCL 0603-1N0 □-N	1.0	4	100	10	0.11	470
HCL 0603-1N2 □-N	1.2	4	100	10	0.12	450
HCL 0603-1N5 □-N	1.5	4	100	10	0.13	430
HCL 0603-1N8 □-N	1.8	4	100	10	0.16	390
HCL 0603-2N0 □-N	2.0	4	100	8.8	0.17	380
HCL 0603-2N1 □-N	2.1	4	100	8.8	0.18	370
HCL 0603-2N2 □-N	2.2	4	100	8.8	0.19	360
HCL 0603-2N4 □-N	2.4	4	100	8.3	0.20	350
HCL 0603-2N7 □-N	2.7	4	100	7.7	0.21	340
HCL 0603-3N0 □-N	3.0	4	100	7.2	0.22	330
HCL 0603-3N3 □-N	3.3	4	100	6.7	0.23	320
HCL 0603-3N6 □-N	3.6	4	100	6.4	0.25	310
HCL 0603-3N9 □-N	3.9	4	100	6.0	0.27	300
HCL 0603-4N3 □-N	4.3	4	100	5.7	0.30	290
HCL 0603-4N7 □-N	4.7	4	100	5.3	0.31	280
HCL 0603-5N1 □-N	5.1	4	100	5.0	0.33	270
HCL 0603-5N6 □-N	5.6	4	100	4.6	0.36	260
HCL 0603-6N2 □-N	6.2	4	100	4.2	0.38	250
HCL 0603-6N8 □-N	6.8	4	100	3.9	0.39	245
HCL 0603-7N5 □-N	7.5	4	100	3.6	0.41	240
HCL 0603-8N2 □-N	8.2	4	100	3.4	0.45	230
HCL 0603-9N1 □-N	9.1	4	100	3.2	0.48	220
HCL 0603-10N □-N	10	4	100	2.9	0.51	210
HCL 0603-12N □-N	12	4	100	2.7	0.68	190
HCL 0603-15N □-N	15	4	100	2.3	0.71	180
HCL 0603-18N □-N	18	4	100	2.1	0.81	170
HCL 0603-22N □-N	22	4	100	1.8	1.00	150
HCL 0603-27N □-N	27	4	100	1.8	1.35	120
HCL 0603-33N □-N	33	4	100	1.7	1.47	110

CORE MASTER ENTERPRISE CO., LTD.



<http://www.coremaster.com.tw>

MULTILAYER HIGH FREQUENCY CHIP INDUCTORS / HCL TYPE

ELECTRICAL CHARACTERISTICS FOR HCL1005

Part No.	Inductance (nH)	Q Min	Test Freq. (MHz)	Self Resonant Freq. (GHz) Min	DC Resistance (Ω) Max	Rated Current (mA) Max
HCL 1005-1N0 □-N	1.0	8	100	8.0	0.10	300
HCL 1005-1N2 □-N	1.2	8	100	8.0	0.11	300
HCL 1005-1N5 □-N	1.5	8	100	8.0	0.12	300
HCL 1005-1N8 □-N	1.8	8	100	6.0	0.13	300
HCL 1005-2N0 □-N	2.0	8	100	6.0	0.14	300
HCL 1005-2N2 □-N	2.2	8	100	6.0	0.15	300
HCL 1005-2N4 □-N	2.4	8	100	6.0	0.16	300
HCL 1005-2N7 □-N	2.7	8	100	6.0	0.17	300
HCL 1005-3N0 □-N	3.0	8	100	6.0	0.18	300
HCL 1005-3N3 □-N	3.3	8	100	6.0	0.19	300
HCL 1005-3N6 □-N	3.6	8	100	6.0	0.20	300
HCL 1005-3N9 □-N	3.9	8	100	6.0	0.21	300
HCL 1005-4N3 □-N	4.3	8	100	4.0	0.22	300
HCL 1005-4N7 □-N	4.7	8	100	6.0	0.23	300
HCL 1005-5N1 □-N	5.1	8	100	6.0	0.24	300
HCL 1005-5N6 □-N	5.6	8	100	5.3	0.26	300
HCL 1005-6N2 □-N	6.2	8	100	4.3	0.27	300
HCL 1005-6N8 □-N	6.8	8	100	4.2	0.29	300
HCL 1005-7N5 □-N	7.5	8	100	4.2	0.31	300
HCL 1005-8N2 □-N	8.2	8	100	3.6	0.33	300
HCL 1005-9N1 □-N	9.1	8	100	3.4	0.34	300
HCL 1005-10N □-N	10	8	100	3.2	0.35	300
HCL 1005-12N □-N	12	8	100	2.8	0.41	300
HCL 1005-15N □-N	15	8	100	2.3	0.46	300
HCL 1005-18N □-N	18	8	100	2.1	0.51	300
HCL 1005-22N □-N	22	8	100	1.8	0.58	300
HCL 1005-27N □-N	27	8	100	1.6	0.67	300
HCL 1005-33N □-N	33	8	100	1.5	0.82	200
HCL 1005-39N □-N	39	8	100	1.2	1.06	200
HCL 1005-47N □-N	47	8	100	1.0	1.15	200
HCL 1005-56N □-N	56	8	100	0.8	1.20	200
HCL 1005-68N □-N	68	8	100	0.8	1.25	180
HCL 1005-82N □-N	82	8	100	0.6	1.60	150
HCL 1005-R10 □-N	100	8	100	0.6	1.90	150
HCL 1005- R12 □-N	120	8	100	0.6	2.20	150
HCL 1005- R15 □-N	150	8	100	0.5	2.99	140
HCL 1005- R18 □-N	180	8	100	0.5	3.38	140
HCL 1005- R22 □-N	220	8	100	0.5	3.77	120
HCL 1005- R27 □-N	270	8	100	0.4	4.90	110

CORE MASTER ENTERPRISE CO., LTD.



<http://www.coremaster.com.tw>

MULTILAYER HIGH FREQUENCY CHIP INDUCTORS / HCL TYPE

ELECTRICAL CHARACTERISTICS FOR HCL1608

Part No.	Inductance (nH)	Q Min	Test Freq. (MHz)	Self Resonant Freq. (GHz) Min	DC Resistance (Ω) Max	Rated Current (mA) Max
HCL 1608-1N0 □-N	1.0	8	100	10	0.05	300
HCL 1608-1N2 □-N	1.2	8	100	10	0.06	300
HCL 1608-1N5 □-N	1.5	8	100	6	0.07	300
HCL 1608-1N8 □-N	1.8	8	100	6	0.08	300
HCL 1608-2N2 □-N	2.2	8	100	6	0.09	300
HCL 1608-2N7 □-N	2.7	10	100	6	0.10	300
HCL 1608-3N3 □-N	3.3	10	100	6	0.12	300
HCL 1608-3N9 □-N	3.9	10	100	6	0.14	300
HCL 1608-4N7 □-N	4.7	10	100	4	0.16	300
HCL 1608-5N6 □-N	5.6	10	100	4	0.18	300
HCL 1608-6N8 □-N	6.8	10	100	4	0.22	300
HCL 1608-8N2 □-N	8.2	10	100	3.50	0.24	300
HCL 1608-10N □-N	10	12	100	3.40	0.26	300
HCL 1608-12N □-N	12	12	100	2.60	0.28	300
HCL 1608-15N □-N	15	12	100	2.30	0.32	300
HCL 1608-18N □-N	18	12	100	2.00	0.35	300
HCL 1608-22N □-N	22	12	100	1.60	0.40	300
HCL 1608-27N □-N	27	12	100	1.40	0.45	300
HCL 1608-33N □-N	33	12	100	1.20	0.55	300
HCL 1608-39N □-N	39	12	100	1.10	0.60	300
HCL 1608-47N □-N	47	12	100	0.90	0.70	300
HCL 1608-56N □-N	56	12	100	0.90	0.75	300
HCL 1608-68N □-N	68	12	100	0.70	0.85	300
HCL 1608-82N □-N	82	12	100	0.60	0.95	300
HCL 1608-R10 □-N	100	12	100	0.60	1.00	300
HCL 1608-R12 □-N	120	8	50	0.50	1.10	300
HCL 1608-R15 □-N	150	8	50	0.50	1.20	300
HCL 1608-R18 □-N	180	8	50	0.40	1.30	300
HCL 1608-R22 □-N	220	8	50	0.40	1.50	300
HCL 1608-R27 □-N	270	8	50	0.40	1.90	300
HCL 1608-R33 □-N	330	8	50	0.35	2.10	300
HCL 1608-R39 □-N	390	8	50	0.35	2.30	150
HCL 1608-R47 □-N	470	8	50	0.30	2.60	150

CORE MASTER ENTERPRISE CO., LTD.



<http://www.coremaster.com.tw>

MULTILAYER HIGH FREQUENCY CHIP INDUCTORS / HCL TYPE

ELECTRICAL CHARACTERISTICS FOR HCL2012

Part No.	Inductance (nH)	Q Min	Test Freq. (MHz)	Self Resonant Freq. (GHz) Min	DC Resistance (Ω) Max	Rated Current (mA) Max
HCL 2012-1N0 □-N	1.0	10	100	10	0.10	300
HCL 2012-1N2 □-N	1.2	10	100	10	0.11	300
HCL 2012-1N5 □-N	1.5	10	100	4.00	0.12	300
HCL 2012-1N8 □-N	1.8	10	100	4.00	0.13	300
HCL 2012-2N2 □-N	2.2	10	100	4.00	0.14	300
HCL 2012-2N7 □-N	2.7	12	100	4.00	0.15	300
HCL 2012-3N3 □-N	3.3	12	100	4.00	0.16	300
HCL 2012-3N9 □-N	3.9	12	100	4.00	0.18	300
HCL 2012-4N7 □-N	4.7	12	100	3.50	0.20	300
HCL 2012-5N6 □-N	5.6	15	100	3.20	0.23	300
HCL 2012-6N8 □-N	6.8	15	100	2.80	0.25	300
HCL 2012-8N2 □-N	8.2	15	100	2.40	0.28	300
HCL 2012-10N □-N	10	15	100	2.10	0.30	300
HCL 2012-12N □-N	12	15	100	1.90	0.35	300
HCL 2012-15N □-N	15	15	100	1.60	0.40	300
HCL 2012-18N □-N	18	15	100	1.50	0.45	300
HCL 2012-22N □-N	22	18	100	1.40	0.50	300
HCL 2012-27N □-N	27	18	100	1.30	0.55	300
HCL 2012-33N □-N	33	18	100	1.20	0.60	300
HCL 2012-39N □-N	39	18	100	1.00	0.65	300
HCL 2012-47N □-N	47	18	100	0.90	0.70	300
HCL 2012-56N □-N	56	18	100	0.80	0.75	300
HCL 2012-68N □-N	68	18	100	0.70	0.80	300
HCL 2012-82N □-N	82	18	100	0.60	0.85	300
HCL 2012-R10 □-N	100	18	100	0.60	0.90	300
HCL 2012-R12 □-N	120	13	50	0.50	0.95	300
HCL 2012-R15 □-N	150	13	50	0.50	1.00	300
HCL 2012-R18 □-N	180	13	50	0.40	1.10	300
HCL 2012-R22 □-N	220	12	50	0.35	1.20	300
HCL 2012-R27 □-N	270	12	50	0.30	1.30	300
HCL 2012-R33 □-N	330	12	50	0.25	1.40	300
HCL 2012-R39 □-N	390	10	50	0.25	1.60	300
HCL 2012-R47 □-N	470	10	50	0.20	2.00	300
HCL 2012-R56 □-N	560	10	25	0.18	5.00	50
HCL 2012-R68 □-N	680	10	25	0.16	5.50	50

CORE MASTER ENTERPRISE CO., LTD.



<http://www.coremaster.com.tw>

WIRE WOUND CERAMIC CHIP INDUCTORS / WHI TYPE

FEATURES

- ◆ Their ceramic construction delivers the highest possible SRF's and Q value.
- ◆ These ultra-compact inductors provided exceptional Q values, even at high.
- ◆ The non-magnetic coil form also assures the utmost in thermal stability, predictability and batch consistency.



APPLICATIONS

- ◆ Cellular phone, GPS receiver, Base Station, Repeater , Wireless LAN/Mouse/Keyboard/earphone, remote control, security system and other RF modules.

ORDERING CODE

WHI 1008 - 1R0 □-N

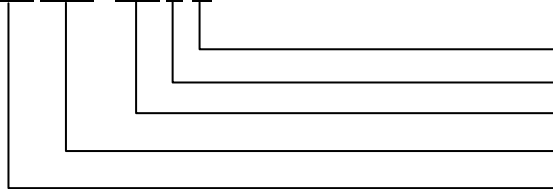

Note: lead-free
Tolerance (G:±2%, J:±5%, K:±10%)
Inductance
Dimension
Product Symbol

SHAPES

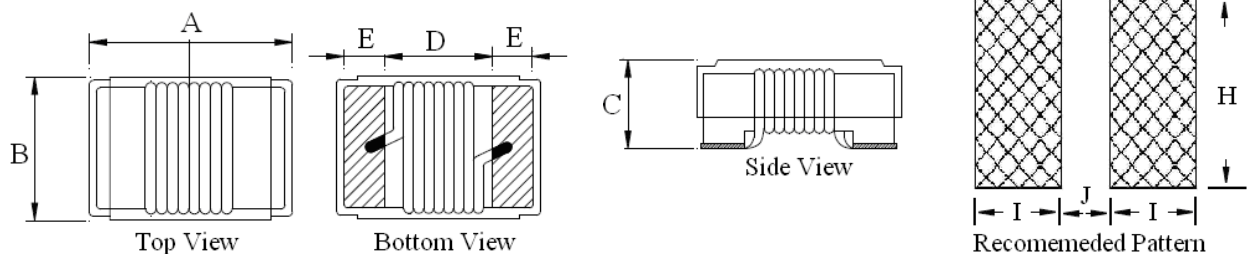

DIMENSIONS (UNIT: mm)

Part No.	A (Max)	B (Max)	C (Max)	D (Ref)	E (Ref)	H (Ref)	I (Ref)	J (Ref)
WHI 0402	1.19	0.64	0.66	0.56	0.23	0.66	0.36	0.46
WHI 0603	1.80	1.12	1.02	0.86	0.33	1.02	0.64	0.64
WHI 0805	2.29	1.73	1.52	1.02	0.51	1.78	1.02	0.76
WHI 1008	2.92	2.79	2.03	1.52	0.51	2.54	1.27	1.27



CORE MASTER ENTERPRISE CO., LTD.

<http://www.coremaster.com.tw>

WIRE WOUND CERAMIC CHIP INDUCTORS / WHI TYPE

ELECTRICAL CHARACTERISTICS FOR WHI 0402

Part No.	Inductance (nH) @250MHz	Q Min	SRF (GHz) Min	DC Resistance (Ω) Max	Rated Current (mA) Max
WHI 0402-1N0 □-N	1.0	16	12.70	0.045	1360
WHI 0402-1N2 □-N	1.2	16	12.90	0.090	740
WHI 0402-1N8 □-N	1.8	16	12.00	0.070	1040
WHI 0402-1N9 □-N	1.9	16	11.30	0.070	1040
WHI 0402-2N0 □-N	2.0	16	11.10	0.070	1040
WHI 0402-2N2 □-N	2.2	19	10.80	0.070	960
WHI 0402-2N4 □-N	2.4	15	10.50	0.068	790
WHI 0402-2N7 □-N	2.7	16	10.40	0.120	640
WHI 0402-3N3 □-N	3.3	19	7.00	0.066	840
WHI 0402-3N6 □-N	3.6	19	6.80	0.066	840
WHI 0402-3N9 □-N	3.9	19	6.00	0.066	840
WHI 0402-4N3 □-N	4.3	18	6.00	0.091	700
WHI 0402-4N7 □-N	4.7	15	4.70	0.130	640
WHI 0402-5N1 □-N	5.1	20	4.80	0.083	800
WHI 0402-5N6 □-N	5.6	20	4.80	0.083	760
WHI 0402-6N2 □-N	6.2	20	4.80	0.083	760
WHI 0402-6N8 □-N	6.8	20	4.80	0.083	680
WHI 0402-7N3 □-N	7.3	20	4.80	0.260	680
WHI 0402-7N5 □-N	7.5	22	4.80	0.100	680
WHI 0402-8N2 □-N	8.2	22	4.40	0.100	680
WHI 0402-8N7 □-N	8.7	18	4.10	0.200	480
WHI 0402-9N1 □-N	9.1	22	4.16	0.100	680
WHI 0402-9N5 □-N	9.5	18	4.00	0.200	480
WHI 0402-10N □-N	10	21	3.90	0.200	480
WHI 0402-11N □-N	11	24	3.68	0.120	640
WHI 0402-12N □-N	12	24	3.60	0.120	640
WHI 0402-13N □-N	13	24	3.45	0.210	440
WHI 0402-15N □-N	15	24	3.28	0.170	560
WHI 0402-16N □-N	16	24	3.10	0.220	560
WHI 0402-18N □-N	18	25	3.10	0.230	420
WHI 0402-19N □-N	19	24	3.04	0.200	480
WHI 0402-20N □-N	20	25	3.00	0.250	420
WHI 0402-22N □-N	22	25	2.80	0.300	400
WHI 0402-23N □-N	23	22	2.72	0.300	400
WHI 0402-24N □-N	24	25	2.70	0.300	400
WHI 0402-30N □-N	30	25	2.35	0.300	400
WHI 0402-33N □-N	33	24	2.35	0.440	400
WHI 0402-36N □-N	36	24	2.32	0.440	320
WHI 0402-39N □-N	39	25	2.10	0.550	200
WHI 0402-40N □-N	40	24	2.24	0.440	320
WHI 0402-43N □-N	43	25	2.03	0.810	100
WHI 0402-47N □-N	47	20	2.10	0.830	150
WHI 0402-51N □-N	51	25	1.75	0.820	100
WHI 0402-56N □-N	56	22	1.76	0.970	100
WHI 0402-68N □-N	68	22	1.62	1.120	100
WHI 0402-82N □-N	82	20	1.26	1.550	50
WHI 0402-R10 □-N	100	20	1.16	2.000	30
WHI 0402-R12 □-N	120	20	1.90	2.200	50

CORE MASTER ENTERPRISE CO., LTD.



<http://www.coremaster.com.tw>

WIRE WOUND CERAMIC CHIP INDUCTORS / WHI TYPE

ELECTRICAL CHARACTERISTICS FOR WHI 0603

Part No.	Inductance (nH)	Q Min	SRF (MHz) Min	DC Resistance (Ω) Max	Rated Current (mA) Max
WHI 0603-1N6 □-N	1.6@250MHz	24	12500	0.030	700
WHI 0603-1N8 □-N	1.8@250MHz	16	12500	0.045	700
WHI 0603-2N2 □-N	2.2@100MHz	20	5800	0.050	700
WHI 0603-3N3 □-N	3.3@250MHz	20	5500	0.070	700
WHI 0603-3N6 □-N	3.6@250MHz	22	5900	0.063	700
WHI 0603-3N9 □-N	3.9@250MHz	22	6900	0.080	700
WHI 0603-4N3 □-N	4.3@250MHz	22	5900	0.063	700
WHI 0603-4N7 □-N	4.7@250MHz	20	5800	0.116	700
WHI 0603-5N1 □-N	5.1@250MHz	20	5700	0.140	700
WHI 0603-5N6 □-N	5.6@250MHz	20	5800	0.150	700
WHI 0603-6N1 □-N	6.1@250MHz	25	5800	0.110	700
WHI 0603-6N8 □-N	6.8@250MHz	27	5800	0.110	700
WHI 0603-7N5 □-N	7.5@250MHz	28	4800	0.106	700
WHI 0603-8N2 □-N	8.2@250MHz	25	5800	0.120	700
WHI 0603-8N4 □-N	8.4@250MHz	28	4600	0.109	700
WHI 0603-8N5 □-N	8.5@250MHz	28	4600	0.109	700
WHI 0603-8N7 □-N	8.7@250MHz	28	4600	0.109	700
WHI 0603-9N5 □-N	9.5@250MHz	28	5400	0.135	700
WHI 0603-10N □-N	10@250MHz	31	4800	0.130	700
WHI 0603-11N □-N	11@250MHz	33	4000	0.086	700
WHI 0603-12N □-N	12@250MHz	35	4000	0.130	700
WHI 0603-14N □-N	14@250MHz	35	4000	0.170	700
WHI 0603-15N □-N	15@250MHz	35	4000	0.170	700
WHI 0603-16N □-N	16@250MHz	34	3300	0.104	700
WHI 0603-18N □-N	18@250MHz	35	3100	0.170	700
WHI 0603-22N □-N	22@250MHz	38	3000	0.190	700
WHI 0603-24N □-N	24@250MHz	37	2650	0.135	700
WHI 0603-27N □-N	27@250MHz	40	2800	0.220	600
WHI 0603-30N □-N	30@250MHz	37	2250	0.144	600
WHI 0603-33N □-N	33@250MHz	40	2300	0.220	600
WHI 0603-36N □-N	36@250MHz	38	2080	0.250	600
WHI 0603-39N □-N	39@250MHz	40	2200	0.250	600
WHI 0603-43N □-N	43@250MHz	39	2000	0.280	600
WHI 0603-47N □-N	47@200MHz	38	2000	0.280	600
WHI 0603-56N □-N	56@200MHz	38	1900	0.310	600
WHI 0603-68N □-N	68@200MHz	37	1700	0.340	600
WHI 0603-72N □-N	72@150MHz	34	1700	0.490	400
WHI 0603-82N □-N	82@150MHz	34	1700	0.540	400
WHI 0603-R10 □-N	100@150MHz	34	1400	0.580	400
WHI 0603-R11 □-N	110@150MHz	32	1350	0.610	300
WHI 0603-R12 □-N	120@150MHz	32	1300	0.650	300
WHI 0603-R15 □-N	150@150MHz	28	990	0.920	280
WHI 0603-R18 □-N	180@100MHz	25	990	1.250	240
WHI 0603-R22 □-N	220@100MHz	25	900	1.900	200
WHI 0603-R27 □-N	270@100MHz	24	900	2.300	170
WHI 0603-R33 □-N	330@100MHz	24	900	3.900	185
WHI 0603-R39 □-N	390@100MHz	25	900	4.350	100
WHI 0603-R47 □-N	470@100MHz	25	820	4.350	100

CORE MASTER ENTERPRISE CO., LTD.



<http://www.coremaster.com.tw>

WIRE WOUND CERAMIC CHIP INDUCTORS / WHI TYPE

ELECTRICAL CHARACTERISTICS FOR WHI 0805

Part No.	Inductance (nH)	Q Min	SRF (MHz) Min	DC Resistance (Ω) Max	Rated Current (mA) Max
WHI 0805-3N3 □-N	3.3@250MHz	50@1500MHz	7900	0.08	600
WHI 0805-5N6 □-N	5.6@250MHz	65@1000MHz	5500	0.08	600
WHI 0805-6N8 □-N	6.8@250MHz	50@1000MHz	5500	0.11	600
WHI 0805-7N5 □-N	7.5@250MHz	50@1000MHz	4500	0.14	600
WHI 0805-8N2 □-N	8.2@250MHz	50@1000MHz	4700	0.12	600
WHI 0805-10N □-N	10@250MHz	60@500MHz	4200	0.10	600
WHI 0805-12N □-N	12@250MHz	50@500MHz	4000	0.15	600
WHI 0805-15N □-N	15@250MHz	50@500MHz	3400	0.17	600
WHI 0805-18N □-N	18@250MHz	50@500MHz	3300	0.20	600
WHI 0805-22N □-N	22@250MHz	55@500MHz	2600	0.22	500
WHI 0805-24N □-N	24@250MHz	50@500MHz	2000	0.22	500
WHI 0805-27N □-N	27@250MHz	55@500MHz	2500	0.25	500
WHI 0805-33N □-N	33@250MHz	60@500MHz	2050	0.27	500
WHI 0805-36N □-N	36@250MHz	55@500MHz	1700	0.27	500
WHI 0805-39N □-N	39@250MHz	60@500MHz	2000	0.29	500
WHI 0805-43N □-N	43@200MHz	60@500MHz	1650	0.34	500
WHI 0805-47N □-N	47@200MHz	60@500MHz	1650	0.31	500
WHI 0805-56N □-N	56@200MHz	60@500MHz	1550	0.34	500
WHI 0805-68N □-N	68@200MHz	60@500MHz	1450	0.38	500
WHI 0805-82N □-N	82@150MHz	65@500MHz	1300	0.42	400
WHI 0805-91N □-N	91@150MHz	65@500MHz	1200	0.48	400
WHI 0805-R10 □-N	100@150MHz	65@500MHz	1200	0.46	400
WHI 0805-R12 □-N	120@150MHz	50@250MHz	1100	0.51	400
WHI 0805-R15 □-N	150@100MHz	50@250MHz	920	0.56	400
WHI 0805-R18 □-N	180@100MHz	50@250MHz	870	0.64	400
WHI 0805-R22 □-N	220@100MHz	50@250MHz	850	0.70	400
WHI 0805-R24 □-N	240@100MHz	44@250MHz	690	1.00	350
WHI 0805-R27 □-N	270@100MHz	48@250MHz	650	1.00	350
WHI 0805-R30 □-N	300@150MHz	25@250MHz	450	1.40	300
WHI 0805-R33 □-N	330@100MHz	48@250MHz	600	1.40	310
WHI 0805-R39 □-N	390@100MHz	48@250MHz	560	1.50	290
WHI 0805-R47 □-N	470@50MHz	33@100MHz	375	1.76	250
WHI 0805-R56 □-N	560@25MHz	23@50MHz	340	1.90	230
WHI 0805-R68 □-N	680@25MHz	23@50MHz	188	2.20	190
WHI 0805-R75 □-N	750@25MHz	23@50MHz	215	2.35	180
WHI 0805-R82 □-N	820@25MHz	23@50MHz	215	2.35	180
WHI 0805-1R0 □-N	1000@25MHz	23@50MHz	260	2.70	170

WIRE WOUND CERAMIC CHIP INDUCTORS / WHI TYPE

ELECTRICAL CHARACTERISTICS FOR WHI 1008

Part No.	Inductance (nH)	Q Min	SRF (MHz) Min	DC Resistance (Ω) Max	Rated Current (mA) Max
WHI 1008-10N □-N	10@50MHz	50@500MHz	4100	0.08	1000
WHI 1008-12N □-N	12@50MHz	50@500MHz	3300	0.09	1000
WHI 1008-15N □-N	15@50MHz	50@500MHz	2500	0.10	1000
WHI 1008-18N □-N	18@50MHz	50@350MHz	2500	0.11	1000
WHI 1008-22N □-N	22@50MHz	55@350MHz	2400	0.12	1000
WHI 1008-24N □-N	24@50MHz	50@350MHz	1500	0.13	1000
WHI 1008-27N □-N	27@50MHz	55@350MHz	1600	0.13	1000
WHI 1008-33N □-N	33@50MHz	60@350MHz	1600	0.14	1000
WHI 1008-39N □-N	39@50MHz	60@350MHz	1500	0.15	1000
WHI 1008-47N □-N	47@50MHz	65@350MHz	1500	0.16	1000
WHI 1008-56N □-N	56@50MHz	65@350MHz	1300	0.18	1000
WHI 1008-68N □-N	68@50MHz	65@350MHz	1300	0.20	1000
WHI 1008-82N □-N	82@50MHz	60@350MHz	1000	0.22	1000
WHI 1008-R10 □-N	100@25MHz	60@350MHz	1000	0.56	650
WHI 1008-R12 □-N	120@25MHz	60@350MHz	950	0.63	650
WHI 1008-R15 □-N	150@25MHz	45@100MHz	850	0.70	580
WHI 1008-R18 □-N	180@25MHz	45@100MHz	750	0.77	620
WHI 1008-R20 □-N	200@25MHz	50@100MHz	750	0.81	500
WHI 1008-R22 □-N	220@25MHz	45@100MHz	700	0.84	500
WHI 1008-R24 □-N	240@25MHz	50@100MHz	600	0.84	500
WHI 1008-R27 □-N	270@25MHz	45@100MHz	600	0.91	500
WHI 1008-R30 □-N	300@150MHz	40@100MHz	500	1.05	660
WHI 1008-R33 □-N	330@25MHz	45@100MHz	570	1.05	450
WHI 1008-R36 □-N	360@150MHz	40@100MHz	500	1.05	660
WHI 1008-R39 □-N	390@25MHz	45@100MHz	500	1.12	470
WHI 1008-R43 □-N	430@150MHz	40@100MHz	425	1.19	600
WHI 1008-R47 □-N	470@25MHz	45@100MHz	450	1.19	470
WHI 1008-R56 □-N	560@25MHz	45@100MHz	415	1.33	400
WHI 1008-R62 □-N	620@25MHz	45@100MHz	375	1.40	300
WHI 1008-R68 □-N	680@25MHz	45@100MHz	375	1.47	400
WHI 1008-R75 □-N	750@25MHz	45@100MHz	360	1.54	360
WHI 1008-R82 □-N	820@25MHz	45@100MHz	350	1.61	400
WHI 1008-R91 □-N	910@25MHz	35@50MHz	320	1.68	380
WHI 1008-1R0 □-N	1000@25MHz	35@50MHz	290	1.75	370
WHI 1008-1R2 □-N	1200@7.9MHz	35@50MHz	250	2.00	310
WHI 1008-1R5 □-N	1500@7.9MHz	28@50MHz	200	2.30	330
WHI 1008-1R8 □-N	1800@7.9MHz	28@50MHz	160	2.60	300
WHI 1008-2R0 □-N	2000@7.9MHz	25@50MHz	160	2.80	280
WHI 1008-2R2 □-N	2200@7.9MHz	28@50MHz	160	2.80	280
WHI 1008-2R7 □-N	2700@7.9MHz	22@25MHz	140	3.20	290
WHI 1008-3R3 □-N	3300@7.9MHz	22@25MHz	110	3.40	290
WHI 1008-3R9 □-N	3900@7.9MHz	20@25MHz	100	3.60	260
WHI 1008-4R7 □-N	4700@7.9MHz	20@25MHz	90	4.00	260

CORE MASTER ENTERPRISE CO., LTD.

<http://www.coremaster.com.tw>



WIRE WOUND CHIP MOLDED INDUCTORS / WCI TYPE

FEATURES

- ◆ Terminals are highly resistant to pull forces.
- ◆ Very strong solder ability by flow soldering, soldering iron or wave soldering.
- ◆ Highly reliable in environments of sudden temperature change and humidity.
- ◆ Highly accurate dimensions can be mounted automatically.
- ◆ Highly resistant to mechanical shocks and pressure.



APPLICATIONS

- ◆ Video cameras, portable VCRs
- ◆ television tuners, mobile telephones
- ◆ Car radios, car stereos, thin tape radios
- ◆ Microtelevisions, Liquid crystal televisions
- ◆ other electronic devices

ORDERING CODE

WCI 3225 - 100 □ - N

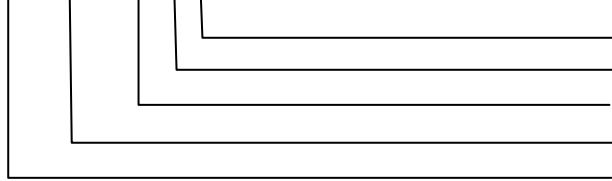

Note: lead-free
Tolerance (J:±5%, K:±10%, M:±20%)
Inductance
Dimension (Ax B)
Product Symbol

SHAPES

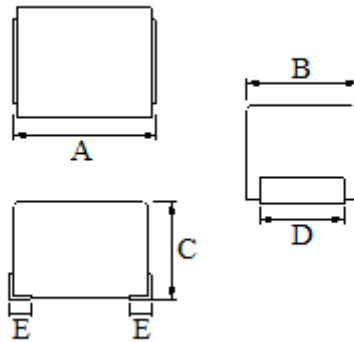

DIMENSIONS UNIT: mm

Part No.	A	B	C	D (REF)	E (REF)
WCI 2520	2.5 ± 0.3	2.0 ± 0.2	1.8 ± 0.2	1.4	0.3
WCI 3225	3.2 ± 0.3	2.5 ± 0.2	2.2 ± 0.2	1.9	0.3
WCI 4532	4.5 ± 0.3	3.2 ± 0.2	3.2 ± 0.2	1.2	1.0

WIRE WOUND CHIP MOLDED INDUCTORS / WCI TYPE

ELECTRICAL CHARACTERISTICS FOR WCI 2520

Part No.	Inductance (uH)	Test Freq. (MHz)	Q Min	Self Resonant FREQ. (MHz) Min	DC Resistance (Ω) Max	Rated Current (mA) Max
WCI 2520-010 □-N	0.010	100	15	2150	0.26	530
WCI 2520-012 □-N	0.012	100	15	2050	0.27	500
WCI 2520-015 □-N	0.015	100	15	2000	0.29	480
WCI 2520-018 □-N	0.018	100	15	1850	0.31	450
WCI 2520-022 □-N	0.022	100	15	1650	0.37	420
WCI 2520-027 □-N	0.027	100	15	1550	0.40	410
WCI 2520-033 □-N	0.033	100	20	1450	0.42	400
WCI 2520-039 □-N	0.039	100	20	1350	0.45	380
WCI 2520-047 □-N	0.047	100	20	1200	0.50	360
WCI 2520-056 □-N	0.056	100	20	1100	0.60	340
WCI 2520-068 □-N	0.068	100	20	1050	0.65	320
WCI 2520-082 □-N	0.082	100	20	900	0.75	300
WCI 2520-R10 □-N	0.100	100	20	800	0.80	280
WCI 2520-R12 □-N	0.120	25.2	30	700	0.30	550
WCI 2520-R15 □-N	0.150	25.2	30	550	0.35	500
WCI 2520-R18 □-N	0.180	25.2	30	500	0.40	460
WCI 2520-R22 □-N	0.220	25.2	30	450	0.50	430
WCI 2520-R27 □-N	0.270	25.2	30	425	0.55	420
WCI 2520-R33 □-N	0.330	25.2	30	400	0.60	400
WCI 2520-R39 □-N	0.390	25.2	30	375	0.65	375
WCI 2520-R47 □-N	0.470	25.2	30	350	0.68	350
WCI 2520-R56 □-N	0.560	25.2	30	325	0.75	325
WCI 2520-R68 □-N	0.680	25.2	30	300	0.85	300
WCI 2520-R82 □-N	0.820	25.2	30	260	1.00	260
WCI 2520-1R0 □-N	1.0	7.96	30	245	1.10	245
WCI 2520-1R2 □-N	1.2	7.96	30	230	1.20	230
WCI 2520-1R5 □-N	1.5	7.96	30	182	1.30	220
WCI 2520-1R8 □-N	1.8	7.96	30	135	1.45	210
WCI 2520-2R2 □-N	2.2	7.96	30	105	1.55	200
WCI 2520-2R7 □-N	2.7	7.96	30	70	1.70	195
WCI 2520-3R3 □-N	3.3	7.96	30	55	1.90	185
WCI 2520-3R9 □-N	3.9	7.96	30	48	2.10	180
WCI 2520-4R7 □-N	4.7	7.96	30	43	2.30	175
WCI 2520-5R6 □-N	5.6	7.96	25	42	2.50	170
WCI 2520-6R8 □-N	6.8	7.96	25	39	2.70	165
WCI 2520-8R2 □-N	8.2	7.96	25	36	3.05	160
WCI 2520-100 □-N	10	2.52	25	30	3.50	155
WCI 2520-120 □-N	12	2.52	25	28	3.80	150
WCI 2520-150 □-N	15	2.52	25	24	4.40	140
WCI 2520-180 □-N	18	2.52	25	22	4.80	130
WCI 2520-220 □-N	22	2.52	25	20	5.50	125
WCI 2520-270 □-N	27	2.52	25	18	6.30	115
WCI 2520-330 □-N	33	2.52	25	16	7.10	110
WCI 2520-390 □-N	39	2.52	20	14	9.50	90
WCI 2520-470 □-N	47	2.52	20	12	11.10	80
WCI 2520-560 □-N	56	2.52	20	12	12.10	75
WCI 2520-680 □-N	68	2.52	20	10	16.60	70
WCI 2520-820 □-N	82	2.52	20	10	19.00	66
WCI 2520-101 □-N	100	0.796	15	8	21.00	60

CORE MASTER ENTERPRISE CO., LTD.



<http://www.coremaster.com.tw>

WIRE WOUND CHIP MOLDED INDUCTORS / WCI TYPE

ELECTRICAL CHARACTERISTICS FOR WCI 3225

Part No.	Inductance (uH)	Test Freq. (MHz)	Q Min	Self Resonant FREQ. (MHz) Min	DC Resistance (Ω) Max	Rated Current (mA) Max
WCI 3225-010 □-N	0.010	100	15	2500	0.13	450
WCI 3225-012 □-N	0.012	100	17	2300	0.14	450
WCI 3225-015 □-N	0.015	100	19	2100	0.16	450
WCI 3225-018 □-N	0.018	100	21	1900	0.18	450
WCI 3225-022 □-N	0.022	100	23	1700	0.20	450
WCI 3225-027 □-N	0.027	100	23	1500	0.22	450
WCI 3225-033 □-N	0.033	100	25	1400	0.24	450
WCI 3225-039 □-N	0.039	100	25	1300	0.27	450
WCI 3225-047 □-N	0.047	100	26	1200	0.30	450
WCI 3225-056 □-N	0.056	100	26	1100	0.33	450
WCI 3225-068 □-N	0.068	100	27	1000	0.36	450
WCI 3225-082 □-N	0.082	100	27	900	0.40	450
WCI 3225-R10 □-N	0.100	100	28	700	0.44	450
WCI 3225-R12 □-N	0.120	25.2	30	500	0.22	450
WCI 3225-R15 □-N	0.150	25.2	30	450	0.25	450
WCI 3225-R18 □-N	0.180	25.2	30	400	0.28	450
WCI 3225-R22 □-N	0.220	25.2	30	350	0.32	450
WCI 3225-R27 □-N	0.270	25.2	30	320	0.36	450
WCI 3225-R33 □-N	0.330	25.2	30	300	0.40	450
WCI 3225-R39 □-N	0.390	25.2	30	250	0.45	450
WCI 3225-R47 □-N	0.470	25.2	30	220	0.50	450
WCI 3225-R56 □-N	0.560	25.2	30	180	0.55	450
WCI 3225-R68 □-N	0.680	25.2	30	160	0.60	450
WCI 3225-R82 □-N	0.820	25.2	30	140	0.65	450
WCI 3225-1R0 □-N	1.00	7.96	30	120	0.70	400
WCI 3225-1R2 □-N	1.20	7.96	30	100	0.75	390
WCI 3225-1R5 □-N	1.50	7.96	30	85	0.85	370
WCI 3225-1R8 □-N	1.80	7.96	30	80	0.90	350
WCI 3225-2R2 □-N	2.20	7.96	30	75	1.00	320
WCI 3225-2R7 □-N	2.70	7.96	30	70	1.10	290
WCI 3225-3R3 □-N	3.30	7.96	30	60	1.20	260
WCI 3225-3R9 □-N	3.90	7.96	30	55	1.30	250
WCI 3225-4R7 □-N	4.70	7.96	30	50	1.50	220
WCI 3225-5R6 □-N	5.60	7.96	30	45	1.60	200
WCI 3225-6R8 □-N	6.80	7.96	30	40	1.80	180
WCI 3225-8R2 □-N	8.20	7.96	30	35	2.00	170
WCI 3225-100 □-N	10	2.52	30	30	2.10	150
WCI 3225-120 □-N	12	2.52	30	25	2.50	140
WCI 3225-150 □-N	15	2.52	30	20	2.80	130
WCI 3225-180 □-N	18	2.52	30	20	3.30	120
WCI 3225-220 □-N	22	2.52	30	20	3.70	110
WCI 3225-270 □-N	27	2.52	30	18	5.00	80
WCI 3225-330 □-N	33	2.52	30	17	5.60	70
WCI 3225-390 □-N	39	2.52	30	16	6.40	65
WCI 3225-470 □-N	47	2.52	30	15	7.00	60
WCI 3225-560 □-N	56	2.52	30	13	8.00	55
WCI 3225-680 □-N	68	2.52	30	12	9.00	50
WCI 3225-820 □-N	82	2.52	30	11	10	45
WCI 3225-101 □-N	100	0.796	20	10	10	40
WCI 3225-121 □-N	120	0.796	20	9	11	70
WCI 3225-151 □-N	150	0.796	20	7	15	65
WCI 3225-181 □-N	180	0.796	20	7	17	60
WCI 3225-221 □-N	220	0.796	20	6	21	50
WCI 3225-271 □-N	270	0.796	20	5	28	45
WCI 3225-331 □-N	330	0.796	20	5	34	40

CORE MASTER ENTERPRISE CO., LTD.



<http://www.coremaster.com.tw>

WIRE WOUND CHIP MOLDED INDUCTORS / WCI TYPE

ELECTRICAL CHARACTERISTICS FOR WCI 4532

Part No.	Inductance (uH)	Test Freq. (MHz)	Q Min	Self Resonant FREQ. (MHz) Min	DC Resistance (Ω) Max	Rated Current (mA) Max
WCI 4532-R10 □-N	0.10	25.2	35	300	0.18	800
WCI 4532-R12 □-N	0.12	25.2	35	280	0.20	770
WCI 4532-R15 □-N	0.15	25.2	35	250	0.22	730
WCI 4532-R18 □-N	0.18	25.2	35	220	0.24	700
WCI 4532-R22 □-N	0.22	25.2	40	200	0.25	665
WCI 4532-R27 □-N	0.27	25.2	40	180	0.26	635
WCI 4532-R33 □-N	0.33	25.2	40	165	0.28	605
WCI 4532-R39 □-N	0.39	25.2	40	150	0.30	575
WCI 4532-R47 □-N	0.47	25.2	40	145	0.32	545
WCI 4532-R56 □-N	0.56	25.2	40	140	0.36	520
WCI 4532-R68 □-N	0.68	25.2	40	135	0.40	500
WCI 4532-R82 □-N	0.82	25.2	40	130	0.45	475
WCI 4532-1R0 □-N	1.00	7.96	50	100	0.50	450
WCI 4532-1R2 □-N	1.20	7.96	50	80	0.55	430
WCI 4532-1R5 □-N	1.50	7.96	50	70	0.60	410
WCI 4532-1R8 □-N	1.80	7.96	50	60	0.65	390
WCI 4532-2R2 □-N	2.20	7.96	50	55	0.70	380
WCI 4532-2R7 □-N	2.70	7.96	50	50	0.75	370
WCI 4532-3R3 □-N	3.30	7.96	50	45	0.80	355
WCI 4532-3R9 □-N	3.90	7.96	50	40	0.90	330
WCI 4532-4R7 □-N	4.70	7.96	50	35	1.00	315
WCI 4532-5R6 □-N	5.60	7.96	50	33	1.10	300
WCI 4532-6R8 □-N	6.80	7.96	50	27	1.20	285
WCI 4532-8R2 □-N	8.20	7.96	50	25	1.40	270
WCI 4532-100 □-N	10	2.52	50	20	1.60	250
WCI 4532-120 □-N	12	2.52	50	18	2.00	225
WCI 4532-150 □-N	15	2.52	50	17	2.50	200
WCI 4532-180 □-N	18	2.52	50	15	2.80	190
WCI 4532-220 □-N	22	2.52	50	13	3.20	180
WCI 4532-270 □-N	27	2.52	50	12	3.60	170
WCI 4532-330 □-N	33	2.52	50	11	4.00	160
WCI 4532-390 □-N	39	2.52	50	10	4.50	150
WCI 4532-470 □-N	47	2.52	50	10	5.00	140
WCI 4532-560 □-N	56	2.52	50	9	5.50	135
WCI 4532-680 □-N	68	2.52	50	9	6.00	130
WCI 4532-820 □-N	82	2.52	50	8	7.00	120
WCI 4532-101 □-N	100	0.796	40	8	8.00	110
WCI 4532-121 □-N	120	0.796	40	6	8.00	110
WCI 4532-151 □-N	150	0.796	40	5	9.00	105
WCI 4532-181 □-N	180	0.796	40	5	9.50	102
WCI 4532-221 □-N	220	0.796	40	4	10	100
WCI 4532-271 □-N	270	0.796	40	4	12	92
WCI 4532-331 □-N	330	0.796	40	3.5	14	85
WCI 4532-391 □-N	390	0.796	40	3	18	80
WCI 4532-471 □-N	470	0.796	30	3	26	62
WCI 4532-561 □-N	560	0.796	30	3	30	50
WCI 4532-681 □-N	680	0.796	30	3	30	50
WCI 4532-821 □-N	820	0.796	30	2.5	35	30
WCI 4532-102 □-N	1000	2.252	20	2.5	40	30

CORE MASTER ENTERPRISE CO., LTD.



<http://www.coremaster.com.tw>

WIRE WOUND FERRITE CHIP INDUCTORS / WCIL TYPE

FEATURES

- ◆ Very strong solderability by reflow soldering and soldering iron or wave soldering.
- ◆ Highly accurate dimensions can be mounted automatically.
- ◆ Terminals are highly resistant to pull forces.
- ◆ High reliable in environments of sudden temperature change and humidity.
- ◆ Highly resistant to mechanical shocks and pressure.
- ◆ Superior Q characteristics and broadest selections amount peers.



APPLICATIONS

- ◆ Micro TVs, liquid crystal TVs, video cameras, portable VCRs, car radios, car stereos, thin tape radios, television tuners, mobile telephones, radio and other electronic devices.

ORDERING CODE

WCIL 2012 - R12 □ - N

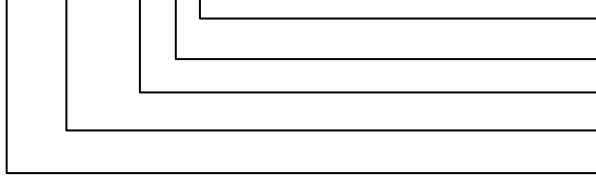

Note: lead-free
Tolerance (J:± 5%, K:±10%)
Inductance
Dimension
Product Symbol

SHAPES

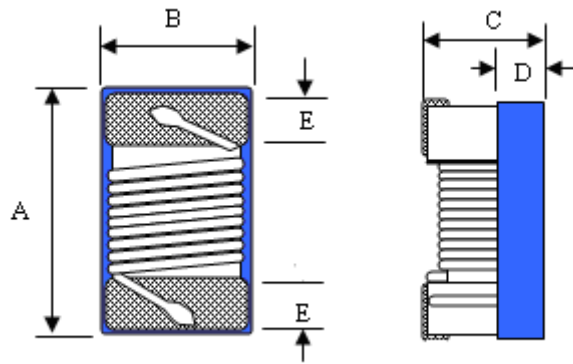

DIMENSIONS UNIT: mm

Part No.	A (MAX)	B (MAX)	C (MAX)	D (REF)	E (REF)
WCIL 2012	2.40	1.65	1.30	0.65	0.44
WCIL 2520	2.90	2.54	2.03	1.30	0.50

CORE MASTER ENTERPRISE CO., LTD.

<http://www.coremaster.com.tw>



WIRE WOUND FERRITE CHIP INDUCTORS / WCIL TYPE

ELECTRICAL CHARACTERISTICS FOR WCIL 2012

Part No.	Inductance (uH)	Test Freq. (MHz)	Q Min	Self Resonant FREQ. (MHz) Min	DC Resistance (Ω) Max	Rated Current (mA) Max
WCIL 2012-R12 □-N	0.12	25	25	1000	0.18	1500
WCIL 2012-R15 □-N	0.15	25	25	1000	0.18	1400
WCIL 2012-R18 □-N	0.18	25	25	1000	0.20	1400
WCIL 2012-R22 □-N	0.22	25	25	830	0.25	1350
WCIL 2012-R27 □-N	0.27	25	25	800	0.38	1300
WCIL 2012-R33 □-N	0.33	25	25	750	0.35	1200
WCIL 2012-R39 □-N	0.39	25	25	700	0.35	1160
WCIL 2012-R47 □-N	0.47	25	25	690	0.40	1100
WCIL 2012-R56 □-N	0.56	25	25	640	0.40	1040
WCIL 2012-R62 □-N	0.62	25	25	640	0.45	980
WCIL 2012-R68 □-N	0.68	25	25	510	0.50	900
WCIL 2012-R82 □-N	0.82	25	25	500	0.50	900
WCIL 2012-R91 □-N	0.91	25	25	500	0.55	900
WCIL 2012-1R0 □-N	1.00	7.9	7.9	470	0.60	840
WCIL 2012-1R2 □-N	1.20	7.9	7.9	400	0.75	800
WCIL 2012-1R5 □-N	1.50	7.9	7.9	400	1.00	720
WCIL 2012-1R8 □-N	1.80	7.9	7.9	230	1.00	660
WCIL 2012-2R2 □-N	2.20	7.9	7.9	200	1.05	600
WCIL 2012-2R7 □-N	2.70	7.9	7.9	130	1.18	500
WCIL 2012-3R3 □-N	3.30	7.9	7.9	160	1.26	480
WCIL 2012-3R9 □-N	3.90	7.9	7.9	130	1.75	440
WCIL 2012-4R7 □-N	4.70	7.9	7.9	120	1.87	390
WCIL 2012-5R6 □-N	5.60	7.9	7.9	90	2.00	340
WCIL 2012-6R8 □-N	6.80	7.9	7.9	55	2.15	300
WCIL 2012-8R2 □-N	8.20	7.9	7.9	40	2.37	280
WCIL 2012-100 □-N	10.0	2.5	2.5	40	2.55	260
WCIL 2012-120 □-N	12.0	2.5	2.5	37	2.80	220
WCIL 2012-150 □-N	15.0	2.5	2.5	30	3.80	200
WCIL 2012-180 □-N	18.0	2.5	2.5	23	4.48	180
WCIL 2012-220 □-N	22.0	2.5	2.5	20	6.30	160
WCIL 2012-270 □-N	27.0	2.5	2.5	19	6.85	140
WCIL 2012-330 □-N	33.0	2.5	2.5	18	7.60	120

CORE MASTER ENTERPRISE CO., LTD.



<http://www.coremaster.com.tw>

WIRE WOUND FERRITE CHIP INDUCTORS / WCIL TYPE

ELECTRICAL CHARACTERISTICS FOR WCIL 2520

Part No.	Inductance (uH)	Test Freq. (MHz)	Q Min	Self Resonant FREQ. (MHz) Min	DC Resistance (Ω) Max	Rated Current (mA) Max
WCIL 2520-5N0 □-N	0.005	100	10	3000	0.25	2000
WCIL 2520-10N □-N	0.010	100	10	2500	0.25	1800
WCIL 2520-12N □-N	0.012	100	15	2400	0.26	1700
WCIL 2520-15N □-N	0.015	100	15	2300	0.28	1600
WCIL 2520-18N □-N	0.018	100	15	2200	0.30	1550
WCIL 2520-22N □-N	0.022	100	20	2100	0.35	1500
WCIL 2520-27N □-N	0.027	100	20	2000	0.40	1450
WCIL 2520-33N □-N	0.033	100	30	1600	0.42	1400
WCIL 2520-39N □-N	0.039	100	35	1500	0.45	1350
WCIL 2520-47N □-N	0.047	100	35	1400	0.50	1300
WCIL 2520-56N □-N	0.056	100	35	1300	0.60	1250
WCIL 2520-68N □-N	0.068	100	35	1200	0.65	1240
WCIL 2520-82N □-N	0.082	100	35	1100	0.75	1230
WCIL 2520-R10 □-N	0.10	100	35	800	0.80	1220
WCIL 2520-R12 □-N	0.12	25.2	30	700	0.30	900
WCIL 2520-R15 □-N	0.15	25.2	30	550	0.35	900
WCIL 2520-R18 □-N	0.18	25.2	30	500	0.40	850
WCIL 2520-R22 □-N	0.22	25.2	30	450	0.50	840
WCIL 2520-R27 □-N	0.27	25.2	30	425	0.55	830
WCIL 2520-R33 □-N	0.33	25.2	30	400	0.60	820
WCIL 2520-R39 □-N	0.39	25.2	30	375	0.65	810
WCIL 2520-R47 □-N	0.47	25.2	30	350	0.68	800
WCIL 2520-R56 □-N	0.56	25.2	30	325	0.75	800
WCIL 2520-R68 □-N	0.68	25.2	30	300	0.85	800
WCIL 2520-R82 □-N	0.82	25.2	30	260	1.0	800
WCIL 2520-1R0 □-N	1.0	7.96	25	245	1.1	800
WCIL 2520-1R2 □-N	1.2	7.96	25	230	1.2	790
WCIL 2520-1R5 □-N	1.5	7.96	25	182	1.3	750
WCIL 2520-1R8 □-N	1.8	7.96	25	135	1.45	750
WCIL 2520-2R2 □-N	2.2	7.96	25	105	1.55	750
WCIL 2520-2R7 □-N	2.7	7.96	25	70	1.7	740
WCIL 2520-3R3 □-N	3.3	7.96	25	55	1.9	730
WCIL 2520-3R9 □-N	3.9	7.96	25	48	2.1	700
WCIL 2520-4R7 □-N	4.7	7.96	25	43	2.3	650
WCIL 2520-5R6 □-N	5.6	7.96	20	42	2.5	640
WCIL 2520-6R8 □-N	6.8	7.96	20	39	2.7	630
WCIL 2520-8R2 □-N	8.2	7.96	20	36	3.05	600
WCIL 2520-100 □-N	10	2.52	15	33	3.5	600
WCIL 2520-120 □-N	12	2.52	15	30	3.8	550
WCIL 2520-150 □-N	15	2.52	15	26	4.4	430
WCIL 2520-180 □-N	18	2.52	15	24	4.8	400
WCIL 2520-220 □-N	22	2.52	15	22	5.5	400
WCIL 2520-270 □-N	27	2.52	15	21	6.3	360
WCIL 2520-330 □-N	33	2.52	15	20	7.1	350
WCIL 2520-390 □-N	39	2.52	10	18	9.5	330
WCIL 2520-470 □-N	47	2.52	10	17	11.1	300
WCIL 2520-560 □-N	56	2.52	10	16	12.1	270
WCIL 2520-680 □-N	68	2.52	10	15	16.6	250
WCIL 2520-820 □-N	82	2.52	10	13	19	200
WCIL 2520-101 □-N	100	0.796	8	12	21	120

CORE MASTER ENTERPRISE CO., LTD.



<http://www.coremaster.com.tw>

WIRE WOUND HIGH CURRENT CHIP MOLDED INDUCTORS / WCI (C) TYPE

FEATURES

- ◆ Low RDC, large current type
- ◆ Best for power supply line.
- ◆ Available in 2 sizes.



APPLICATIONS

- ◆ Portable Telephones
- ◆ Personal computers
- ◆ HDDs.
- ◆ Other electronics appliances.

ORDERING CODE

WCI 4532C - 100 □-N

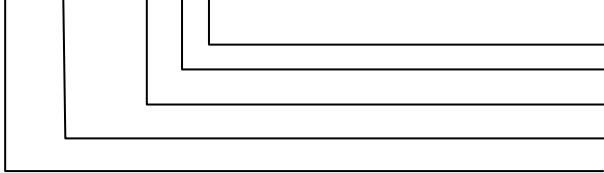

Note: lead-free
Tolerance (J:±5%, K:±10%)
Inductance
Dimension
Product Symbol

SHAPES

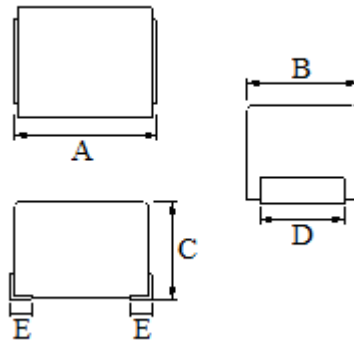

DIMENSIONS UNIT: mm

Part No.	A	B	C	D (REF)	E (REF)
WCI 3225C	3.2 ± 0.3	2.5 ± 0.2	2.2 ± 0.2	1.9	0.3
WCI 4532C	4.5 ± 0.3	3.2 ± 0.2	3.2 ± 0.2	1.2	1.0
WCI 5650C	5.6 ± 0.3	5.0 ± 0.2	4.0 ± 0.4	4.0	0.7

CORE MASTER ENTERPRISE CO., LTD.

<http://www.coremaster.com.tw>



WIRE WOUND HIGH CURRENT CHIP MOLDED INDUCTORS / WCI (C) TYPE

ELECTRICAL CHARACTERISTICS FOR WCI 3225C

Part No.	Inductance (uH)	Test Freq. (MHz)	Q Min	Self Resonant FREQ. (MHz) Min	DC Resistance (Ω) Max	Rated Current (mA) Max
WCI 3225C-R15 □-N	0.15	25.2	5	400	0.25	1350
WCI 3225C-R22 □-N	0.22	25.2	5	250	0.30	1150
WCI 3225C-R47 □-N	0.47	25.2	5	150	0.30	1000
WCI 3225C-1R0 □-N	1.0	7.96	10	100	0.30	850
WCI 3225C-1R5 □-N	1.5	7.96	10	80	0.30	700
WCI 3225C-2R2 □-N	2.2	7.96	10	68	0.30	600
WCI 3225C-3R3 □-N	3.3	7.96	10	54	0.35	500
WCI 3225C-4R7 □-N	4.7	7.96	15	46	0.45	430
WCI 3225C-6R8 □-N	6.8	7.96	15	38	0.50	360
WCI 3225C-100 □-N	10	2.52	15	30	0.80	300
WCI 3225C-150 □-N	15	2.52	15	26	1.60	250
WCI 3225C-220 □-N	22	2.52	15	21	2.20	210
WCI 3225C-330 □-N	33	2.52	15	17	2.80	170
WCI 3225C-470 □-N	47	2.52	15	14	3.20	150
WCI 3225C-560 □-N	56	2.52	15	13	5.00	120
WCI 3225C-680 □-N	68	2.52	15	12	5.00	120
WCI 3225C-820 □-N	82	2.52	15	10	6.50	110
WCI 3225C-101 □-N	100	0.796	15	10	7.50	100
WCI 3225C-151 □-N	150	0.796	20	7	11	85
WCI 3225C-221 □-N	220	0.796	20	6	14	70
WCI 3225C-331 □-N	330	0.796	20	5	21	60

CORE MASTER ENTERPRISE CO., LTD.

<http://www.coremaster.com.tw>



WIRE WOUND HIGH CURRENT CHIP MOLDED INDUCTORS / WCI (C) TYPE

ELECTRICAL CHARACTERISTICS FOR WCI 4532C

Part No.	Inductance (uH)	Test Freq. (MHz)	Q Min	Self Resonant FREQ. (MHz) Min	DC Resistance (Ω) Max	Rated Current (mA) Max
WCI 4532C-1R0 □-N	1.0	7.96	10	180.0	0.11	1050
WCI 4532C-1R2 □-N	1.2	7.96	10	160.0	0.12	1000
WCI 4532C-1R5 □-N	1.5	7.96	10	130.0	0.15	950
WCI 4532C-1R8 □-N	1.8	7.96	10	100.0	0.16	900
WCI 4532C-2R2 □-N	2.2	7.96	10	80.0	0.18	850
WCI 4532C-2R7 □-N	2.7	7.96	10	60.0	0.20	800
WCI 4532C-3R3 □-N	3.3	7.96	10	45.0	0.22	750
WCI 4532C-3R9 □-N	3.9	7.96	10	40.0	0.24	700
WCI 4532C-4R7 □-N	4.7	7.96	10	35.0	0.27	650
WCI 4532C-5R6 □-N	5.6	7.96	10	30.0	0.30	650
WCI 4532C-6R8 □-N	6.8	7.96	10	28.0	0.35	600
WCI 4532C-8R2 □-N	8.2	7.96	10	25.0	0.40	600
WCI 4532C-100 □-N	10	2.52	10	22.0	0.50	550
WCI 4532C-120 □-N	12	2.52	10	21.0	0.60	500
WCI 4532C-150 □-N	15	2.52	10	20.0	0.70	450
WCI 4532C-180 □-N	18	2.52	10	19.0	0.80	400
WCI 4532C-220 □-N	22	2.52	10	18.0	0.90	370
WCI 4532C-270 □-N	27	2.52	10	16.0	1.20	330
WCI 4532C-330 □-N	33	2.52	10	14.0	1.40	300
WCI 4532C-390 □-N	39	2.52	10	12.0	1.60	280
WCI 4532C-470 □-N	47	2.52	10	11.5	1.90	260
WCI 4532C-560 □-N	56	2.52	10	11.0	2.20	240
WCI 4532C-680 □-N	68	2.52	10	10.0	2.60	220
WCI 4532C-820 □-N	82	2.52	10	9.0	3.50	200
WCI 4532C-101 □-N	100	0.796	20	8.0	4.00	180
WCI 4532C-121 □-N	120	0.796	20	7.5	4.50	160
WCI 4532C-151 □-N	150	0.796	20	7.0	6.50	140
WCI 4532C-181 □-N	180	0.796	20	6.5	7.50	120
WCI 4532C-221 □-N	220	0.796	20	5.5	9.00	120
WCI 4532C-271 □-N	270	0.796	20	5.0	11.0	100
WCI 4532C-331 □-N	330	0.796	20	4.0	13.0	90
WCI 4532C-391 □-N	390	0.796	20	3.0	14.0	85
WCI 4532C-471 □-N	470	0.796	20	3.0	16.0	75
WCI 4532C-561 □-N	560	0.796	20	3.0	21.0	70
WCI 4532C-681 □-N	680	0.796	20	2.5	24.2	65

CORE MASTER ENTERPRISE CO., LTD.

<http://www.coremaster.com.tw>



WIRE WOUND HIGH CURRENT CHIP MOLDED INDUCTORS / WCI (C) TYPE

ELECTRICAL CHARACTERISTICS FOR WCI 5650C

Part No.	Inductance (uH)	Test Freq. (MHz)	Q Min	Self Resonant FREQ. (MHz) Min	DC Resistance (Ω) Max	Rated Current (mA) Max
WCI 5650C-1R0 □-N	1.0	7.96	10	95	0.030	1800
WCI 5650C-1R2 □-N	1.2	7.96	10	70	0.035	1700
WCI 5650C-1R5 □-N	1.5	7.96	10	55	0.040	1600
WCI 5650C-1R8 □-N	1.8	7.96	10	47	0.050	1400
WCI 5650C-2R2 □-N	2.2	7.96	10	42	0.060	1300
WCI 5650C-2R7 □-N	2.7	7.96	10	37	0.070	1200
WCI 5650C-3R3 □-N	3.3	7.96	10	34	0.080	1120
WCI 5650C-3R9 □-N	3.9	7.96	10	32	0.090	1050
WCI 5650C-4R7 □-N	4.7	7.96	10	29	0.110	950
WCI 5650C-5R6 □-N	5.6	7.96	10	26	0.130	880
WCI 5650C-6R8 □-N	6.8	7.96	10	24	0.150	810
WCI 5650C-8R2 □-N	8.2	7.96	10	22	0.180	750
WCI 5650C-100 □-N	10	2.52	10	19	0.210	690
WCI 5650C-120 □-N	12	2.52	10	17	0.250	630
WCI 5650C-150 □-N	15	2.52	10	16	0.300	580
WCI 5650C-180 □-N	18	2.52	10	14	0.360	530
WCI 5650C-220 □-N	22	2.52	10	13	0.430	480
WCI 5650C-270 □-N	27	2.52	10	11.5	0.520	440
WCI 5650C-330 □-N	33	2.52	10	10.5	0.620	400
WCI 5650C-390 □-N	39	2.52	10	9.5	0.720	370
WCI 5650C-470 □-N	47	2.52	10	8.5	0.850	340
WCI 5650C-560 □-N	56	2.52	10	7.8	1.000	310
WCI 5650C-680 □-N	68	2.52	10	7.0	1.200	290
WCI 5650C-820 □-N	82	2.52	10	6.4	1.400	270
WCI 5650C-101 □-N	100	0.796	20	6.0	1.600	250
WCI 5650C-121 □-N	120	0.796	20	5.4	1.900	230
WCI 5650C-151 □-N	150	0.796	20	4.8	2.200	210
WCI 5650C-181 □-N	180	0.796	20	4.4	2.800	190
WCI 5650C-221 □-N	220	0.796	20	3.9	3.400	170
WCI 5650C-271 □-N	270	0.796	20	3.6	4.200	155
WCI 5650C-331 □-N	330	0.796	20	3.2	4.900	140
WCI 5650C-391 □-N	390	0.796	20	2.9	5.800	130
WCI 5650C-471 □-N	470	0.796	20	2.6	7.000	120
WCI 5650C-561 □-N	560	0.796	20	2.4	8.500	110
WCI 5650C-681 □-N	680	0.796	20	2.2	10.000	100
WCI 5650C-821 □-N	820	0.796	20	2.0	13.000	90
WCI 5650C-102 □-N	1000	0.252	20	1.8	15.000	85
WCI 5650C-122 □-N	1200	0.252	20	1.5	17.000	75
WCI 5650C-152 □-N	1500	0.252	20	1.4	20.000	70
WCI 5650C-182 □-N	1800	0.252	20	1.3	30.000	60
WCI 5650C-222 □-N	2200	0.252	20	1.2	35.000	55
WCI 5650C-272 □-N	2700	0.252	20	1.1	55.000	45
WCI 5650C-332 □-N	3300	0.252	20	1.0	60.000	40
WCI 5650C-392 □-N	3900	0.252	20	1.0	70.000	38
WCI 5650C-472 □-N	4700	0.252	20	0.9	78.000	36
WCI 5650C-562 □-N	5600	0.252	20	0.8	85.000	33
WCI 5650C-682 □-N	6800	0.252	20	0.7	110.000	30
WCI 5650C-822 □-N	8200	0.252	20	0.6	125.000	28
WCI 5650C-103 □-N	10000	0.0796	15	0.5	150.000	25

CORE MASTER ENTERPRISE CO., LTD.



<http://www.coremaster.com.tw>

WIRE WOUND HIGH CURRENT FERRITE CHIP INDUCTORS / WCIL(C) TYPE

FEATURES

- ◆ Very strong solderability by reflow soldering and soldering iron.
- ◆ Highly accurate dimensions can be mounted automatically.
- ◆ Terminals are highly resistant to pull forces.
- ◆ Highly resistant to mechanical shocks and pressure.
- ◆ Highly reliable in environments of sudden temperature change and humidity.
- ◆ Superior IDC for DC/DC converter.



APPLICATIONS

- ◆ DC/DC converter such as DSC, LCD TV, game console, portable VCRs, conveyable telephone, and others.

ORDERING CODE

WCIL 3225C - 100 □-N

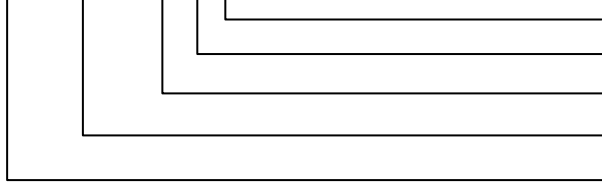

Note: lead-free
Tolerance (J:± 5%, K:±10%)
Inductance
Dimension
Product Symbol

SHAPES

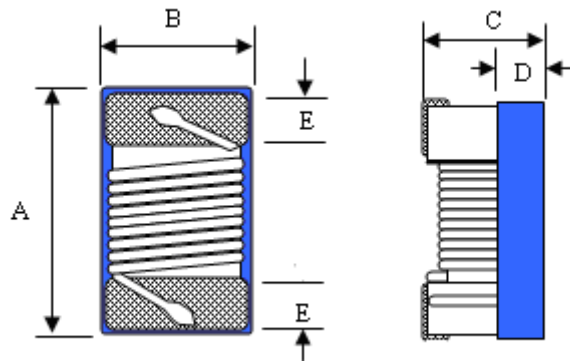

DIMENSIONS UNIT: mm

Part No.	A (MAX)	B (MAX)	C (MAX)	D (REF)	E (REF)
WCIL 2520C	2.90	2.54	2.00	1.3	0.5
WCIL 3225C	3.60	2.90	2.50	1.1	0.5



CORE MASTER ENTERPRISE CO., LTD.

<http://www.coremaster.com.tw>

WIRE WOUND HIGH CURRENT FERRITE CHIP INDUCTORS / WCIL(C) TYPE

ELECTRICAL CHARACTERISTICS FOR WCIL 2520C

Part No.	Inductance (uH)	Test Freq. (MHz)	Q Min	Self Resonant FREQ. (MHz) Min	DC Resistance (Ω) Max	Rated Current (mA) Max
WCIL 2520C-1R0 □-N	1.0	7.96	25	300	0.34	1500
WCIL 2520C-1R5 □-N	1.5	7.96	25	270	0.42	1400
WCIL 2520C-2R2 □-N	2.2	7.96	25	140	0.50	1200
WCIL 2520C-3R3 □-N	3.3	7.96	25	95	0.65	1000
WCIL 2520C-4R7 □-N	4.7	7.96	25	90	0.80	800
WCIL 2520C-6R8 □-N	6.8	7.96	25	68	1.00	730
WCIL 2520C-100 □-N	10	2.52	20	45	1.50	700
WCIL 2520C-150 □-N	15	2.52	20	40	2.20	500
WCIL 2520C-220 □-N	22	2.52	20	25	2.70	470
WCIL 2520C-330 □-N	33	2.52	20	25	4.00	400
WCIL 2520C-470 □-N	47	2.52	16	20	8.00	300

ELECTRICAL CHARACTERISTICS FOR WCIL 3225C

Part No.	Inductance (uH)	Test Freq. (MHz)	Q Min	Self Resonant FREQ. (MHz) Min	DC Resistance (Ω) Max	Rated Current (mA) Max
WCIL 3225C-1R0 □-N	1.0	7.96	20	100	0.08	1500
WCIL 3225C-1R5 □-N	1.5	7.96	20	80	0.13	1125
WCIL 3225C-2R2 □-N	2.2	7.96	20	68	0.13	970
WCIL 3225C-3R3 □-N	3.3	7.96	20	54	0.16	837
WCIL 3225C-4R7 □-N	4.7	7.96	20	43	0.23	675
WCIL 3225C-6R8 □-N	6.8	7.96	20	33	0.27	600
WCIL 3225C-100 □-N	10	2.52	15	28	0.36	520
WCIL 3225C-150 □-N	15	2.52	15	19	0.56	480
WCIL 3225C-220 □-N	22	2.52	15	16	0.77	310
WCIL 3225C-330 □-N	33	2.52	15	12	1.10	270
WCIL 3225C-470 □-N	47	2.52	15	10	1.64	210
WCIL 3225C-680 □-N	68	2.52	15	9	2.80	189
WCIL 3225C-101 □-N	100	0.796	15	6	3.70	145
WCIL 3225C-151 □-N	150	0.796	15	5	6.10	120
WCIL 3225C-221 □-N	220	0.796	15	4	8.40	100
WCIL 3225C-331 □-N	330	0.796	15	3.5	12.3	80
WCIL 3225C-471 □-N	470	0.796	15	2.8	22.0	75
WCIL 3225C-681 □-N	680	0.796	15	2	28.0	65

CORE MASTER ENTERPRISE CO., LTD.



<http://www.coremaster.com.tw>

COMMON MODE CHOKE COILS / LFV TYPE

FEATURES

- ◆ Wide inductance range
- ◆ Easy PC Board Mounting
- ◆ High levels of safety and reliability
- ◆ Available as vertically or horizontally mounted



APPLICATIONS

- ◆ TV, VCR
- ◆ NC machines
- ◆ Peripheral units
- ◆ Computer systems
- ◆ Measuring instruments
- ◆ Switching power sources

ORDERING CODE

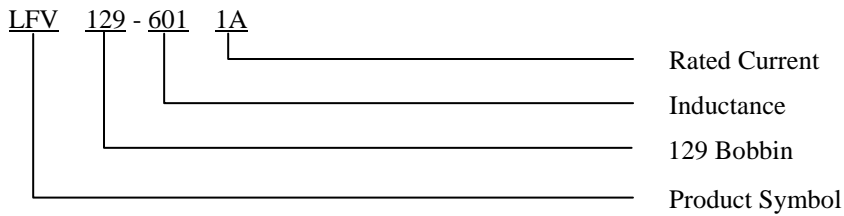

SHAPES & DIMENSIONS (UNIT: mm)

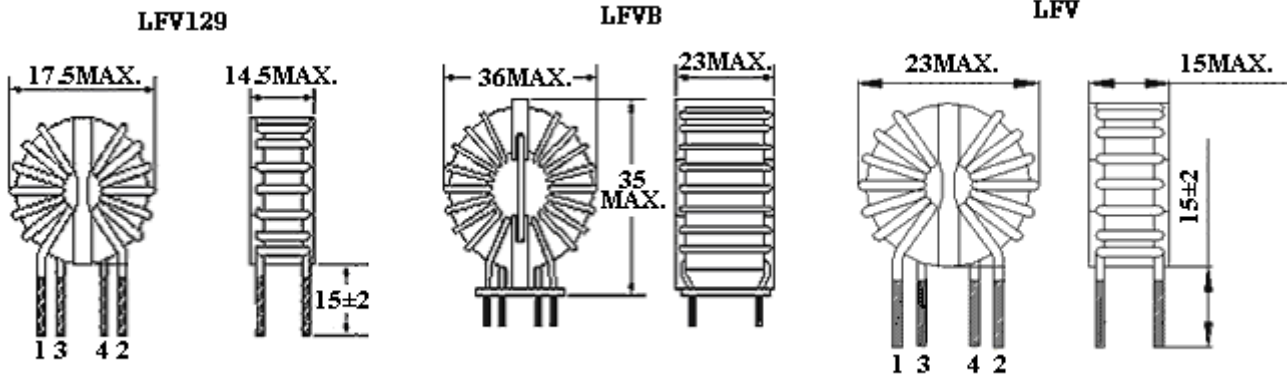

ELECTRICAL CHARACTERISTICS

Part No.	Inductance (mH)	DC Resistance (mΩ)	Rated Current (A)
LFV129	0.6 - 5.0	60 - 150	1 - 3
LFVB	0.2 - 1.5	5 - 45	3 - 15
LFV	1.0 - 10	80 - 260	1 - 2

*DESIGN AS CUSTOMER'S REQUESTED SPECIFICATIONS

CORE MASTER ENTERPRISE CO., LTD.



<http://www.coremaster.com.tw>

COMMON MODE CHOKE COILS / SRF TYPE

FEATURES

- ◆ Enable common-mode noise suppression without influence signals.
- ◆ Ferrite toroid core construction.
- ◆ Magnetically shielded.



APPLICATIONS

- ◆ EMI countermeasures at signal lines of personal computers, microcomputers, peripheral devices, Countermeasures against common-mode noise at composite at video signals.

ORDERING CODE

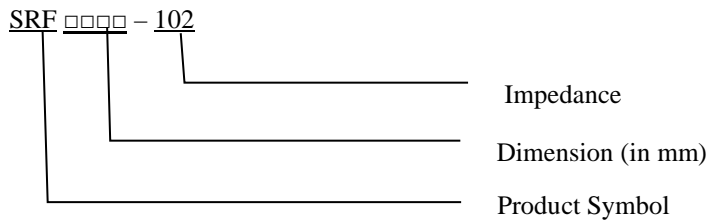

SHAPES

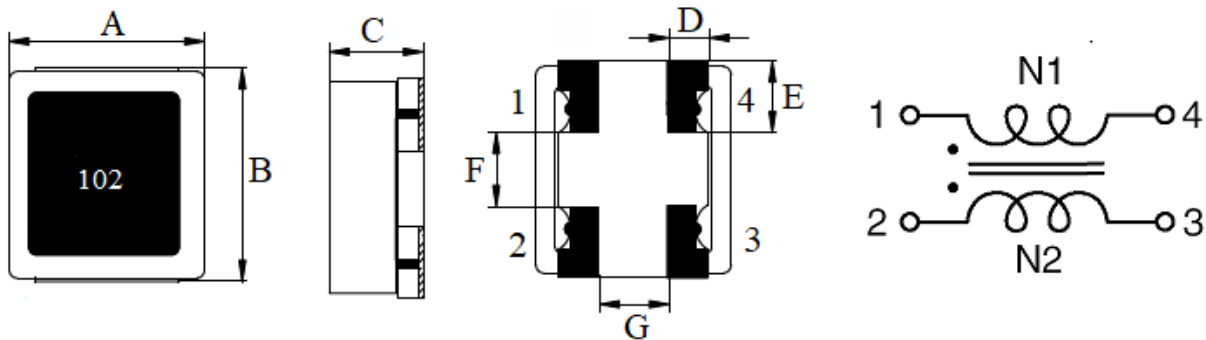

DIMENSIONS (UNIT: mm)

Part No.	A	B	C (Max)	D (Ref.)	E (Ref.)	F (Ref.)	G (Ref.)
SRF 485025	4.8 ± 0.3	5.0 ± 0.3	2.5	1.35	1.7	1.6	1.0
SRF 485045	4.8 ± 0.3	5.0 ± 0.3	4.5	1.35	1.7	1.6	1.0



CORE MASTER ENTERPRISE CO., LTD.

<http://www.coremaster.com.tw>

COMMON MODE CHOKE COILS / SRF TYPE

ELECTRICAL CHARACTERISTICS FOR SRF485025

Part No.	Impedance (Ω) (TYP) N1=N2	Test Frequency (MHz)	DC Resistance (m Ω) (Max)	Rated Current (mA)(Max)
SRF485025-101 □	100	100MHz	12.6	6500
SRF485025-251 □	250	100MHz	19.6	5000
SRF485025-351 □	350	100MHz	20.0	4000
SRF485025-501 □	500	100MHz	26.6	4000
SRF485025-102 □	1000	100MHz	33.6	2000
SRF485025-142 □	1400	100MHz	56.0	1500

ELECTRICAL CHARACTERISTICS FOR SRF485045

Part No.	Impedance (Ω) (TYP) N1=N2	Test Frequency (MHz)	DC Resistance (m Ω) (Max)	Rated Current (mA)(Max)
SRF485045-191 □	190	100MHz	20	5000
SRF485045-351 □	350	100MHz	40	2000
SRF485045-501 □	500	100MHz	50	1800
SRF485045-801 □	800	100MHz	50	1500
SRF485045-102 □	1000	100MHz	60	1500
SRF485045-152 □	1500	100MHz	100	1000
SRF485045-302 □	3000	100MHz	300	500



CORE MASTER ENTERPRISE CO., LTD.

<http://www.coremaster.com.tw>

COMMON MODE SMD POWER INDUCTORS / SRI-4PAD TYPE

FEATURES

- ◆ Low voltage power supply is prosperous accordingly power saving.
- ◆ Four terminals choke coil available for DC-DC converter of less than 3.3V input voltage.



APPLICATIONS

- ◆ TVs and audio equipment.
- ◆ Satellite communication systems.
- ◆ Microwave equipment.

ORDERING CODE

SRI □□□□ - □□□□ - 4PAD

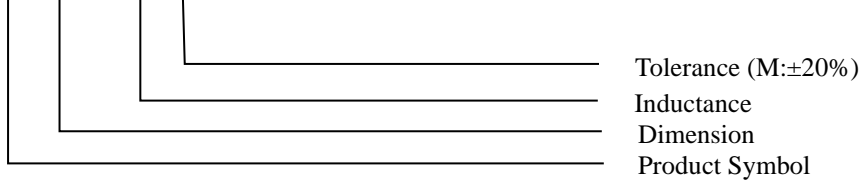

SHAPES

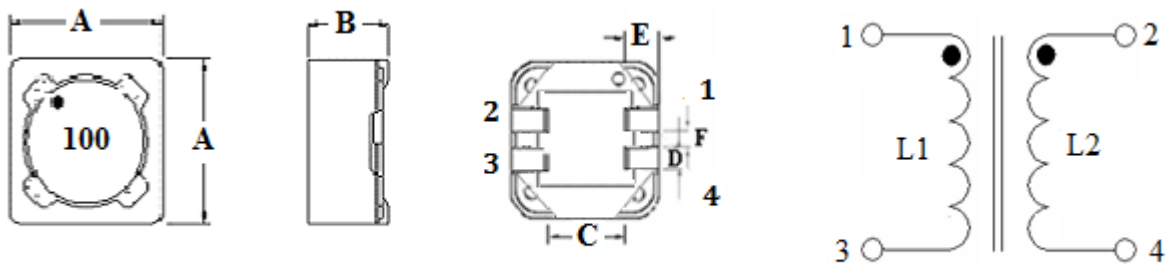

DIMENSIONS (UNIT: mm)

Part No.	A	B (MAX)	C (REF)	D (REF)	E (REF)	F (REF)
SRI0703-4PAD	7.3 ± 0.3	3.5	5.0	0.8	2.1	1.1
SRI0704-4PAD	7.3 ± 0.3	4.8	5.0	0.8	2.1	1.1
SRI1205-4PAD	12.0 ± 0.5	6.5	7.6	2.0	2.9	1.6
SRI1207-4PAD	12.0 ± 0.5	8.5	7.6	2.0	2.9	1.6



CORE MASTER ENTERPRISE CO., LTD.

<http://www.coremaster.com.tw>

COMMON MODE SMD POWER INDUCTORS / SRI-4PAD TYPE

ELECTRICAL CHARACTERISTICS FOR SRI0703**-4PAD

Part No.	L1=L2 (μH)	DCR(mΩ) (max)	IDC (A) (max)
SRI0703-4R7 □-4PAD	4.7	50	3.20
SRI0703-100 □-4PAD	10	200	2.40
SRI0703-200 □-4PAD	20	280	1.60
SRI0703-220 □-4PAD	22	400	1.60
SRI0703-470 □-4PAD	47	560	1.10
SRI0703-510 □-4PAD	51	700	1.00
SRI0703-221 □-4PAD	220	3000	0.53
SRI0703-251 □-4PAD	250	4200	0.34

ELECTRICAL CHARACTERISTICS FOR SRI0704**-4PAD

Part No.	L1=L2(μH)	DCR (mΩ) (max)	IDC (A) (max)
SRI0704-2R5 □-4PAD	2.5	19.8	5.67
SRI0704-3R3 □-4PAD	3.3	24.2	4.86
SRI0704-4R7 □-4PAD	4.7	28.6	4.14
SRI0704-5R6 □-4PAD	5.6	35.2	3.78
SRI0704-6R8 □-4PAD	6.8	38.5	3.51
SRI0704-8R2 □-4PAD	8.2	47.3	3.15
SRI0704-100 □-4PAD	10	55.0	2.70
SRI0704-150 □-4PAD	15	77.0	2.16
SRI0704-220 □-4PAD	22	121	1.89
SRI0704-330 □-4PAD	33	165	1.53
SRI0704-470 □-4PAD	47	231	1.26
SRI0704-560 □-4PAD	56	297	1.17
SRI0704-680 □-4PAD	68	352	1.08
SRI0704-820 □-4PAD	82	396	0.99
SRI0704-101 □-4PAD	100	495	0.88
SRI0704-121 □-4PAD	120	616	0.81
SRI0704-151 □-4PAD	150	742	0.72
SRI0704-181 □-4PAD	180	913	0.65
SRI0704-221 □-4PAD	220	1210	0.59
SRI0704-271 □-4PAD	270	1430	0.54
SRI0704-331 □-4PAD	330	1760	0.48
SRI0704-391 □-4PAD	390	2310	0.45
SRI0704-471 □-4PAD	470	2585	0.41
SRI0704-561 □-4PAD	560	2915	0.37
SRI0704-681 □-4PAD	680	3850	0.34
SRI0704-821 □-4PAD	820	4290	0.31
SRI0704-102 □-4PAD	1000	5940	0.27



CORE MASTER ENTERPRISE CO., LTD.

<http://www.coremaster.com.tw>

COMMON MODE SMD POWER INDUCTORS / SRI-4PAD TYPE

ELECTRICAL CHARACTERISTICS FOR SRI1205**-4PAD

Part No.	L1=L2(μ H)	DCR (m Ω) (max)	IDC (A) (max)
SRI1205-4R7 □-4PAD	4.7	19.8	9.27
SRI1205-5R6 □-4PAD	5.6	22.0	8.69
SRI1205-6R8 □-4PAD	6.8	26.4	8.28
SRI1205-8R2 □-4PAD	8.2	28.6	7.69
SRI1205-100 □-4PAD	10	33.0	6.66
SRI1205-120 □-4PAD	12	40.7	6.17
SRI1205-150 □-4PAD	15	46.2	5.48
SRI1205-180 □-4PAD	18	52.8	4.77
SRI1205-220 □-4PAD	22	63.8	4.50
SRI1205-270 □-4PAD	27	68.2	4.19
SRI1205-330 □-4PAD	33	73.7	3.79
SRI1205-390 □-4PAD	39	78.1	3.42
SRI1205-470 □-4PAD	47	95.7	2.92
SRI1205-560 □-4PAD	56	108	2.76
SRI1205-680 □-4PAD	68	118	2.54
SRI1205-820 □-4PAD	82	150	2.29
SRI1205-101 □-4PAD	100	177	1.98
SRI1205-121 □-4PAD	120	229	1.84
SRI1205-151 □-4PAD	150	261	1.63
SRI1205-181 □-4PAD	180	294	1.44
SRI1205-221 □-4PAD	220	380	1.35
SRI1205-271 □-4PAD	270	443	1.26
SRI1205-331 □-4PAD	330	600	1.15
SRI1205-391 □-4PAD	390	660	1.04
SRI1205-471 □-4PAD	470	874	0.90
SRI1205-561 □-4PAD	560	995	0.85
SRI1205-681 □-4PAD	680	1133	0.79
SRI1205-821 □-4PAD	820	1457	0.71
SRI1205-102 □-4PAD	1000	1683	0.62



CORE MASTER ENTERPRISE CO., LTD.

<http://www.coremaster.com.tw>

COMMON MODE SMD POWER INDUCTORS / SRI-4PAD TYPE

ELECTRICAL CHARACTERISTICS FOR SRI1207**-4PAD

Part No.	L1=L2(μ H)	DCR (m Ω) (max)	IDC (A) (max)
SRI1207-4R7 □-4PAD	4.7	20.9	13.40
SRI1207-5R6 □-4PAD	5.6	25.3	12.00
SRI1207-6R8 □-4PAD	6.8	26.4	11.70
SRI1207-8R2 □-4PAD	8.2	27.5	9.72
SRI1207-100 □-4PAD	10	31.9	9.45
SRI1207-120 □-4PAD	12	34.1	8.64
SRI1207-150 □-4PAD	15	39.6	8.19
SRI1207-180 □-4PAD	18	44.0	7.20
SRI1207-220 □-4PAD	22	52.8	6.12
SRI1207-270 □-4PAD	27	66.0	5.85
SRI1207-330 □-4PAD	33	82.5	5.04
SRI1207-390 □-4PAD	39	88.0	4.95
SRI1207-470 □-4PAD	47	99.0	4.68
SRI1207-560 □-4PAD	56	104	4.05
SRI1207-680 □-4PAD	68	115	3.69
SRI1207-820 □-4PAD	82	154	3.42
SRI1207-101 □-4PAD	100	165	3.06
SRI1207-121 □-4PAD	120	225	2.88
SRI1207-151 □-4PAD	150	253	2.52
SRI1207-181 □-4PAD	180	280	2.25
SRI1207-221 □-4PAD	220	379	2.07
SRI1207-271 □-4PAD	270	495	1.89
SRI1207-331 □-4PAD	330	561	1.71
SRI1207-391 □-4PAD	390	616	1.53
SRI1207-471 □-4PAD	470	841	1.44
SRI1207-561 □-4PAD	560	929	1.35
SRI1207-681 □-4PAD	680	1259	1.17
SRI1207-821 □-4PAD	820	1402	1.08
SRI1207-102 □-4PAD	1000	1556	0.99

* Test Frequency : 100KHZ



CORE MASTER ENTERPRISE CO., LTD.

<http://www.coremaster.com.tw>

FIXED INDUCTORS / AL TYPE

FEATURES

- ◆ Coating epoxy resin that ensures the humidity resistance to be long life.
- ◆ Contribute to be high Q and self-resonant frequencies.



APPLICATIONS

- ◆ Electronics products
- ◆ Communication equipment
- ◆ Computer Devices

ORDERING CODE

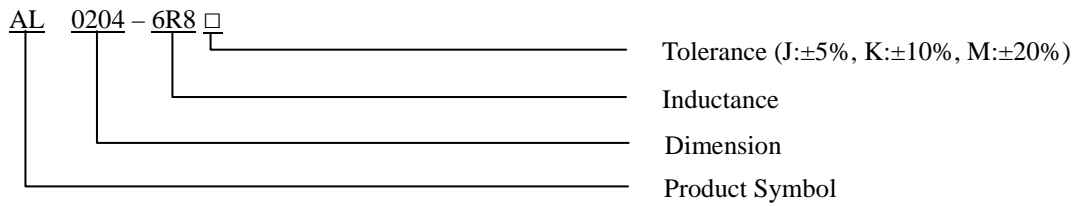

SHAPES & DIMENSIONS (UNIT: mm)

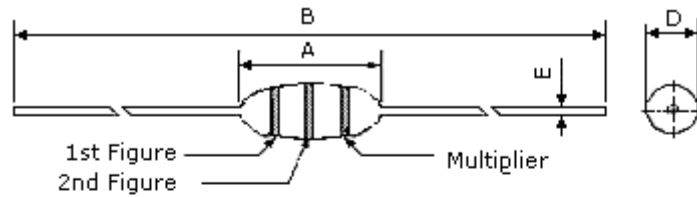

Fig. 1

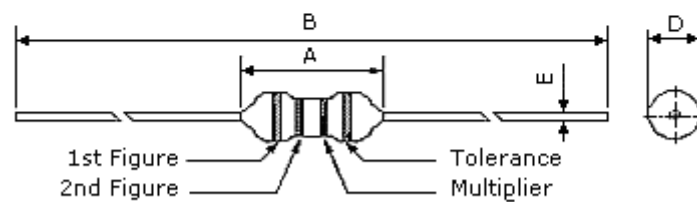

Fig. 2

Part No.	Fig.	A (Max)	B (±2.0)	D (Max)	E (±0.05)
AL 0204	1	4	62	3	0.55
AL 0307	2	8	62	3	0.55
AL 0410	2	12	62	4	0.65
AL 0510	2	12	62	5	0.65

CORE MASTER ENTERPRISE CO., LTD.



<http://www.coremaster.com.tw>

FIXED INDUCTORS / AL TYPE

ELECTRICAL CHARACTERISTICS FOR AL0204

Part No.	Inductance (uH)	Quality Factor (Min)	Test Freq. (MHz)	SRF (MHz) Min	DCR (Ω) Max	IDC (mA) Max
AL 0204-1R0 K	1.0	35	25.2	150	0.80	270
AL 0204-1R2 K	1.2	40	7.96	110	0.90	260
AL 0204-1R5 K	1.5	40	7.96	70	1.00	250
AL 0204-1R8 K	1.8	40	7.96	60	1.10	240
AL 0204-2R2 K	2.2	40	7.96	45	1.20	230
AL 0204-2R7 K	2.7	40	7.96	40	1.30	220
AL 0204-3R3 K	3.3	40	7.96	38	1.40	210
AL 0204-3R9 K	3.9	40	7.96	36	1.50	200
AL 0204-4R7 K	4.7	40	7.96	32	1.70	190
AL 0204-5R6 K	5.6	40	7.96	30	1.90	180
AL 0204-6R8 K	6.8	40	7.96	28	2.00	175
AL 0204-8R2 K	8.2	40	7.96	26	2.20	165
AL 0204-100 K	10	40	7.96	24	2.50	160
AL 0204-120 K	12	40	2.52	22	2.5	150
AL 0204-150 K	15	40	2.52	20	2.8	145
AL 0204-180 K	18	40	2.52	18	3.1	140
AL 0204-220 K	22	40	2.52	17	3.4	130
AL 0204-270 K	27	40	2.52	16	4.3	80
AL 0204-330 K	33	40	2.52	14	4.7	76
AL 0204-390 K	39	40	2.52	13	5.2	76
AL 0204-470 K	47	40	2.52	12	5.8	70
AL 0204-560 K	56	40	2.52	11	6.4	68
AL 0204-680 K	68	40	2.52	10	7.2	64
AL 0204-820 K	82	40	2.52	9.5	11	46
AL 0204-101 K	100	40	2.52	9.0	12	44
AL 0204-121 K	120	40	0.796	8.0	13	42
AL 0204-151 K	150	40	0.796	6.0	16	39
AL 0204-221 K	220	40	0.796	5.6	20	35
AL 0204-271 K	270	40	0.796	4.6	25	28
AL 0204-331 K	330	40	0.796	4.2	30	26
AL 0204-391 K	390	40	0.796	3.8	34	25
AL 0204-471 K	470	40	0.796	2.6	35	24
AL 0204-561 K	560	40	0.796	2.5	40	23
AL 0204-681 K	680	40	0.796	2.2	42	22
AL 0204-821 K	820	40	0.796	2.1	46	21
AL 0204-102 K	1000	40	0.796	2.0	52	20

CORE MASTER ENTERPRISE CO., LTD.



<http://www.coremaster.com.tw>

FIXED INDUCTORS / AL TYPE

ELECTRICAL CHARACTERISTICS FOR AL0307

Part No.	Inductance (uH)	Quality Factor (Min)	Test Freq. (MHz)	SRF (MHz) Min	DCR (Ω) Max	IDC (mA) Max
AL 0307-1R0 K	1.0	40	25.2	180	0.15	700
AL 0307-1R2 K	1.2	40	7.96	165	0.18	740
AL 0307-1R5 K	1.5	40	7.96	150	0.20	700
AL 0307-1R8 K	1.8	50	7.96	125	0.23	655
AL 0307-2R2 K	2.2	50	7.96	110	0.25	630
AL 0307-2R7 K	2.7	50	7.96	95	0.28	595
AL 0307-3R3 K	3.3	50	7.96	70	0.30	575
AL 0307-3R9 K	3.9	50	7.96	65	0.32	555
AL 0307-4R7 K	4.7	50	7.96	50	0.35	530
AL 0307-5R6 K	5.6	50	7.96	40	0.40	500
AL 0307-6R8 K	6.8	50	7.96	30	0.45	470
AL 0307-8R2 K	8.2	50	7.96	28	0.56	425
AL 0307-100 K	10	50	7.96	22	0.75	370
AL 0307-120 K	12	50	2.52	20	0.80	350
AL 0307-150 K	15	50	2.52	16	0.93	335
AL 0307-180 K	18	50	2.52	15	1.00	315
AL 0307-220 K	22	50	2.52	13	1.20	285
AL 0307-270 K	27	50	2.52	11	1.80	270
AL 0307-330 K	33	50	2.52	10	2.10	255
AL 0307-390 K	39	50	2.52	9.5	2.30	240
AL 0307-470 K	47	50	2.52	8.5	2.60	205
AL 0307-560 K	56	50	2.52	7.5	2.90	195
AL 0307-680 K	68	50	2.52	6.5	3.30	185
AL 0307-820 K	82	50	2.52	6.0	3.80	175
AL 0307-101 K	100	50	2.52	5.5	4.20	165
AL 0307-121 K	120	60	0.796	5.4	4.70	160
AL 0307-151 K	150	60	0.796	4.7	5.40	150
AL 0307-181 K	180	60	0.796	4.3	6.00	140
AL 0307-221 K	220	60	0.796	4.0	7.00	130
AL 0307-271 K	270	60	0.796	3.7	7.70	120
AL 0307-331 K	330	60	0.796	3.4	11.1	100
AL 0307-391 K	390	60	0.796	2.8	12.6	95
AL 0307-471 K	470	60	0.796	2.5	14.0	90
AL 0307-561 K	560	60	0.796	2.3	15.5	85
AL 0307-681 K	680	60	0.796	2.0	25.3	75
AL 0307-821 K	820	60	0.796	1.5	27.5	65
AL 0307-102 K	1000	50	0.796	1.2	31.4	60

CORE MASTER ENTERPRISE CO., LTD.



<http://www.coremaster.com.tw>

FIXED INDUCTORS / AL TYPE

ELECTRICAL CHARACTERISTICS FOR AL0410

Part No.	Inductance (uH)	Quality Factor (Min)	Test Freq. (MHz)	SRF (MHz) Min	DCR (Ω) Max	IDC (mA) Max
AL 0410-1R0 K	1.0	45	25.2	157	0.17	920
AL 0410-1R2 K	1.2	50	7.96	144	0.18	880
AL 0410-1R5 K	1.5	50	7.96	131	0.20	830
AL 0410-1R8 K	1.8	55	7.96	121	0.22	790
AL 0410-2R2 K	2.2	55	7.96	110	0.24	750
AL 0410-2R7 K	2.7	60	7.96	100	0.25	720
AL 0410-3R3 K	3.3	65	7.96	94	0.30	670
AL 0410-3R9 K	3.9	65	7.96	86	0.35	640
AL 0410-4R7 K	4.7	70	7.96	80	0.40	620
AL 0410-5R6 K	5.0	70	7.96	74	0.45	590
AL 0410-6R8 K	6.8	75	7.96	68	0.50	550
AL 0410-8R2 K	8.2	80	7.96	53	0.60	530
AL 0410-100 K	10	80	7.96	45	0.65	500
AL 0410-120 K	12	75	2.52	34	0.70	480
AL 0410-150 K	15	70	2.52	20	0.75	460
AL 0410-180 K	18	65	2.52	14	0.80	430
AL 0410-220 K	22	50	2.52	9.9	0.90	410
AL 0410-270 K	27	55	2.52	7.6	1.00	390
AL 0410-330 K	33	55	2.52	6.3	1.10	370
AL 0410-390 K	39	50	2.52	6.3	1.20	350
AL 0410-470 K	47	45	2.52	6.3	1.30	340
AL 0410-560 K	56	40	2.52	6.2	1.50	320
AL 0410-680 K	68	40	2.52	5.7	1.80	305
AL 0410-820 K	82	35	2.52	5.3	2.00	290
AL 0410-101 K	100	30	2.52	4.8	2.50	275
AL 0410-121 K	120	70	0.796	3.8	3.00	185
AL 0410-151 K	150	70	0.796	3.5	4.20	175
AL 0410-181 K	180	70	0.796	3.3	4.60	165
AL 0410-221 K	220	70	0.796	3.0	5.10	155
AL 0410-271 K	270	65	0.796	2.8	6.00	145
AL 0410-331 K	330	65	0.796	2.6	6.50	137
AL 0410-391 K	390	65	0.796	2.4	7.50	133
AL 0410-471 K	470	60	0.796	2.2	8.50	126
AL 0410-561 K	560	60	0.796	2.1	9.50	120
AL 0410-681 K	680	55	0.796	1.9	12	113
AL 0410-821 K	820	55	0.796	1.8	14	105
AL 0410-102 K	1000	50	0.796	1.4	20	85

CORE MASTER ENTERPRISE CO., LTD.



<http://www.coremaster.com.tw>

FIXED INDUCTORS / AL TYPE

ELECTRICAL CHARACTERISTICS FOR AL0510

Part No.	Inductance (uH)	Quality Factor (Min)	Test Freq. (MHz)	SRF (MHz) Min	DCR (Ω) Max	IDC (mA) Max
AL 0510-102 K	1000	80	252	1.30	8	120
AL 0510-122 K	1200	80	252	1.30	9	110
AL 0510-152 K	1500	80	252	1.30	10	100
AL 0510-182 K	1800	80	252	1.20	11	90
AL 0510-222 K	2200	80	252	1.10	14	80
AL 0510-272 K	2700	80	252	0.85	18	75
AL 0510-332 K	3300	80	252	0.74	22	65
AL 0510-392 K	3900	80	252	0.70	26	60
AL 0510-472 K	4700	80	252	0.66	32	55
AL 0510-562 K	5600	70	252	0.64	34	50
AL 0510-682 K	6800	70	252	0.58	45	45
AL 0510-822 K	8200	50	252	0.50	60	40
AL 0510-103 K	10000	50	252	0.48	70	38
AL 0510-123 K	12000	50	252	0.46	82	35
AL 0510-153 K	15000	50	252	0.40	89	32
AL 0510-183 K	18000	40	79.6	0.37	140	28
AL 0510-223 K	22000	40	79.6	0.33	170	25
AL 0510-273 K	27000	40	79.6	0.28	210	23
AL 0510-303 K	30000	40	79.6	0.26	240	22
AL 0510-333 K	33000	40	79.6	0.25	250	20
AL 0510-393 K	39000	40	79.6	0.24	270	16

CORE MASTER ENTERPRISE CO., LTD.



<http://www.coremaster.com.tw>

HIGH CURRENT COMMON MODE CHOKE COILS / CM TYPE

FEATURES

- ◆ High common mode impedance at high frequency effects excellent noise suppression performance.
- ◆ The common mode choke coils structure enables noise suppression without degrading the signal.
- ◆ Suitable for and reflow soldering



APPLICATIONS

- ◆ EMI countermeasures at signal lines of personal computers, microcomputers, peripheral devices, Countermeasures against common-mode noise at composite at video signals.

ORDERING CODE

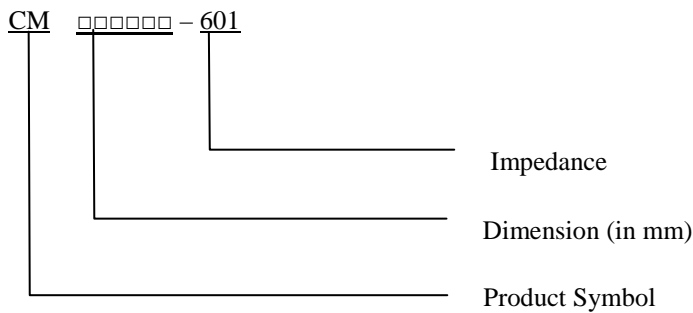

SHAPES

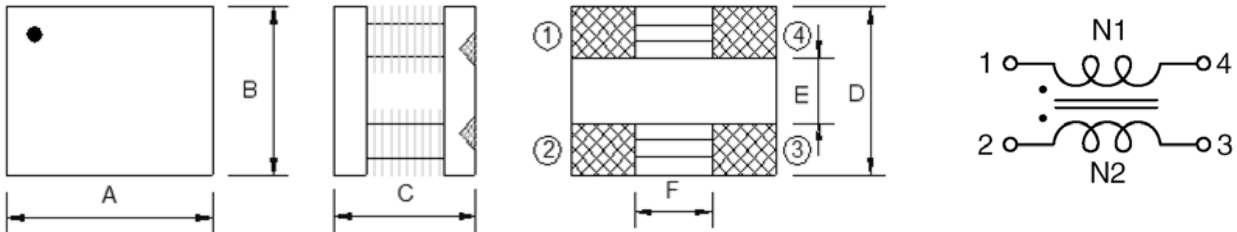

Fig.1

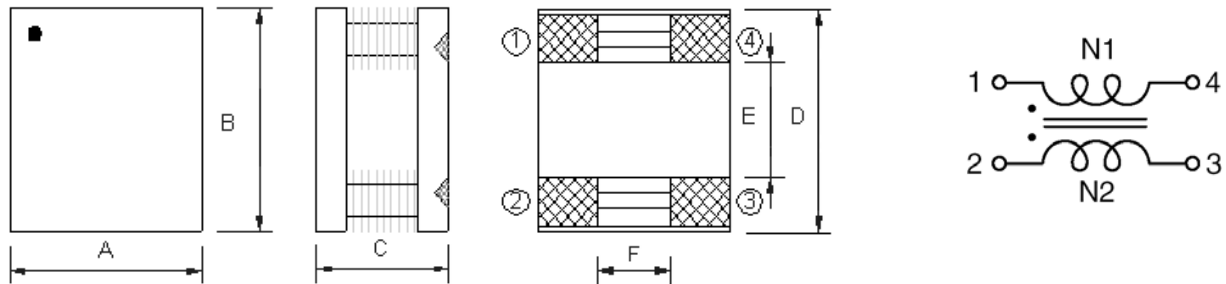

Fig.2

CORE MASTER ENTERPRISE CO., LTD.



<http://www.coremaster.com.tw>

HIGH CURRENT COMMON MODE CHOKE COILS / CM TYPE

DIMENSIONS (UNIT: mm)

Part No.	Fig.	A	B	C	D (Ref.)	E (Ref.)	F (Ref.)
CM508505	1	8.5 ± 0.3	5.00 ± 0.3	5.0 ± 0.3	5.0	1.8	4.0
CM750603	2	6.0 ± 0.3	7.50 ± 0.3	3.2 ± 0.3	7.5	2.5	1.8
CM100805	2	8.0 ± 0.3	10.0 ± 0.3	5.2 ± 0.3	10.0	4.0	2.5
CM121006	2	10.0 ± 0.5	12.0 ± 0.5	6.2 ± 0.3	12.0	5.0	3.0

ELECTRICAL CHARACTERISTICS FOR CM508505

Part No.	Rated Current (mA)	Impedance (Ω) (Ref.)	Test Frequency	DC Resistance (mΩ)(Max)
CM 508505-701	2500	700	100MHz	35
CM 508505-102	2500	1000	100MHz	75
CM 508505-202	2000	2000	100MHz	75
CM 508505-222	2000	2200	100MHz	75

ELECTRICAL CHARACTERISTICS FOR CM750603

Part No.	Rated Current (mA)	Impedance (Ω) (Ref.)	Test Frequency	DC Resistance (mΩ)(Max)
CM 750603-301	5000	300	100MHz	10
CM 750603-601	2500	600	100MHz	45
CM 750603-701	2500	700	100MHz	45

ELECTRICAL CHARACTERISTICS FOR CM100805

Part No.	Rated Current (mA)	Impedance (Ω) (Ref.)	Test Frequency	DC Resistance (mΩ)(Max)
CM 100805-501	5000	500	100MHz	10
CM 100805-601	4000	600	100MHz	30
CM 100805-102	4000	1000	100MHz	30
CM 100805-152	3000	1500	80MHz	60
CM 100805-202	2000	2000	70MHz	75

ELECTRICAL CHARACTERISTICS FOR CM121006

Part No.	Rated Current (mA)	Impedance (Ω) (Ref.)	Test Frequency	DC Resistance (mΩ)(Max)
CM 121006-201	6000	200	100MHz	20
CM 121006-501	5000	500	100MHz	25
CM 121006-901	5000	900	100MHz	25
CM 121006-102	5000	1000	100MHz	25
CM 121006-122	5000	1200	100MHz	45
CM 121006-202	5000	2000	100MHz	45
CM 121006-302	2500	3000	100MHz	150

Note:

- 1, Inductance is measured by LCR-meter 4284A (HP) or equivalent.
- 2, DC Resistance is measured by HP4338B Milliohms Meter or equivalent.

CORE MASTER ENTERPRISE CO., LTD.



<http://www.coremaster.com.tw>

HIGH CURRENT COMMON MODE FILTERS / SCM TYPE

FEATURES

- ◆ High common mode impedance at high frequency effects excellent noise suppression performance.
- ◆ The common mode filters structure enables noise suppression without degrading the signal.
- ◆ Suitable for and reflow soldering

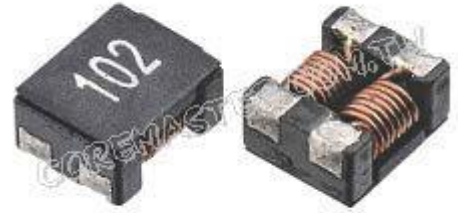

APPLICATIONS

- ◆ EMI countermeasures at signal lines of personal computers, microcomputers, peripheral devices, Countermeasures against common-mode noise at composite at video signals.

ORDERING CODE

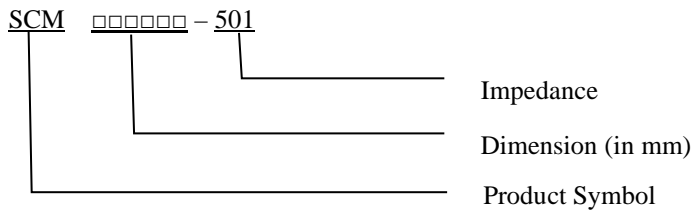

SHAPES

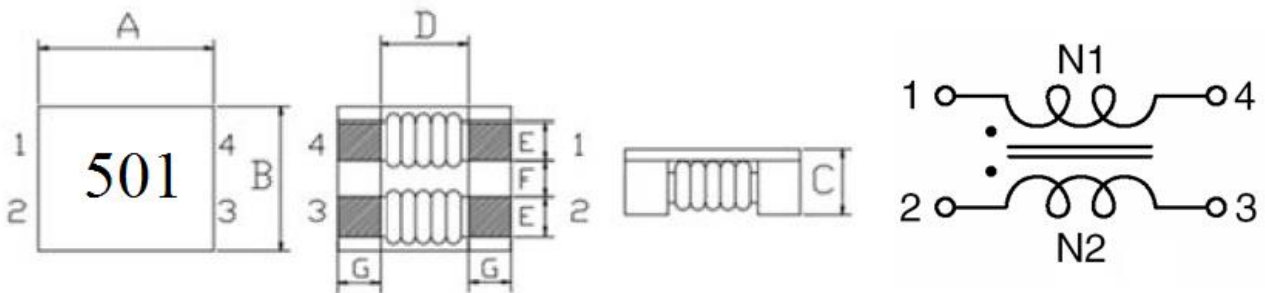

DIMENSIONS (UNIT: mm)

Part No.	A	B	C (Max)	D (Ref.)	E (Ref.)	F (Ref.)	G (Ref.)
SCM474520	4.7 ± 0.5	4.5 ± 0.5	2.2	2.7	0.75	1.26	1.0
SCM706040	7.0 ± 0.5	6.0 ± 0.5	4.0	3.5	1.50	1.50	1.7
SCM907050	9.0 ± 0.5	7.0 ± 0.5	5.0	5.7	1.50	2.00	1.7
SCM121164	12.0 ± 0.5	10.8 ± 0.5	6.4	7.0	2.70	2.50	2.5



CORE MASTER ENTERPRISE CO., LTD.

<http://www.coremaster.com.tw>

HIGH CURRENT COMMON MODE FILTERS / SCM TYPE

ELECTRICAL CHARACTERISTICS FOR SCM474520

Part No.	Impedance (Ω)N1=N2		Test Frequency (MHz)	DC Resistance (m Ω)(Max)	Rated Current (A)(Max)
	Min	Typ			
SCM 474520-900	30	90	100MHz	35	3.2
SCM 474520-151	80	150	100MHz	38	3.1
SCM 474520-231	180	230	100MHz	39	3.0
SCM 474520-301	180	300	100MHz	39	3.0
SCM 474520-401	200	400	100MHz	50	2.5
SCM 474520-501	300	500	100MHz	55	2.4
SCM 474520-701	500	700	100MHz	59	2.2
SCM 474520-901	700	900	100MHz	68	2.1
SCM 474520-102	800	1000	100MHz	68	2.1
SCM 474520-122	1000	1200	100MHz	74	2.0
SCM 474520-142	1200	1400	100MHz	81	1.9

ELECTRICAL CHARACTERISTICS FOR SCM706040

Part No.	Impedance (Ω)N1=N2		Test Frequency (MHz)	DC Resistance (m Ω)(Max)	Rated Current (A)(Max)
	Min	Typ			
SCM 706040-400	40	70	100MHz	5	15
SCM 706040-101	100	140	100MHz	10	9.0
SCM 706040-301	225	300	100MHz	10	5.0
SCM 706040-501	275	350	100MHz	10	5.0
SCM 706040-601	500	700	100MHz	15	4.0
SCM 706040-132	910	1300	100MHz	21	2.5
SCM 706040-222	1700	2200	100MHz	50	1.2
SCM 706040-272	2000	2700	100MHz	63	1.0
SCM 706040-302	2500	3000	100MHz	75	0.9

ELECTRICAL CHARACTERISTICS FOR SCM907050

Part No.	Impedance (Ω)N1=N2		Test Frequency (MHz)	DC Resistance (m Ω)(Max)	Rated Current (A)(Max)
	Min	Typ			
SCM 907050-301	225	300	100MHz	6	6.0
SCM 907050-501	450	600	100MHz	8	6.0
SCM 907050-701	500	700	100MHz	10	5.0
SCM 907050-102	750	1000	100MHz	13	4.0
SCM 907050-222	1700	2200	100MHz	60	2.5
SCM 907050-272	2000	2700	100MHz	65	2.0
SCM 907050-302	2500	3000	100MHz	70	1.9



CORE MASTER ENTERPRISE CO., LTD.

<http://www.coremaster.com.tw>

HIGH CURRENT COMMON MODE FILTERS / SCM TYPE

ELECTRICAL CHARACTERISTICS FOR SCM121164

Part No.	Impedance (Ω)N1=N2		Test Frequency (MHz)	DC Resistance (m Ω)(Max)	Rated Current (A)(Max)
	Min	Typ			
SCM 121164-800	80	230	100MHz	4	10
SCM 121164-701	500	700	100MHz	6	8.0
SCM 121164-801	600	800	100MHz	8	8.0
SCM 121164-102	750	1000	100MHz	14	6.0
SCM 121164-132	910	1300	100MHz	23	4.5
SCM 121164-222	2200	2500	100MHz	35	1.8
SCM 121164-272	2300	2700	100MHz	50	1.5



CORE MASTER ENTERPRISE CO., LTD.

<http://www.coremaster.com.tw>

HIGH CURRENT FILTER CHOKES / HC TYPE

FEATURES

- ◆ Coated with varnish
- ◆ Use ferrite cores
- ◆ Low cost design
- ◆ General purpose inductors
- ◆ High saturation current



APPLICATIONS

- ◆ Output chokes
- ◆ SCR and Triac circuits
- ◆ Power supplies and amplifier
- ◆ Noise filters for switching regulators
- ◆ Other filters

ORDERING CODE

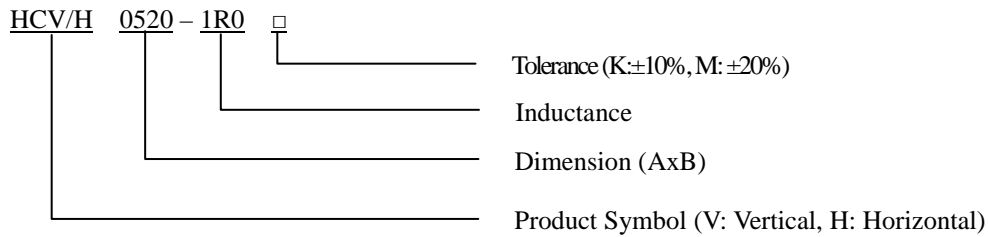

SHAPES

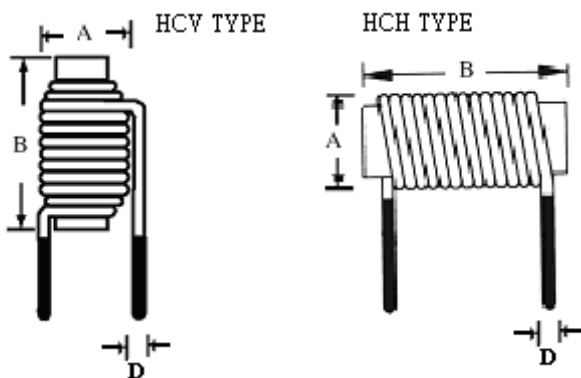

DIMENSIONS (UNIT: mm)

Part No.	A (Max)	B (Max)	D (Ref)
HC 0415	5.5	16.0	0.40
HC 0520	7.0	21.0	0.65
HC 0630	9.5	31.0	1.20

***DESIGN AS CUSTOMER'S REQUESTED SPECIFICATIONS**



CORE MASTER ENTERPRISE CO., LTD.

<http://www.coremaster.com.tw>

LINE FILTERS / LFU TYPE

FEATURES

- ◆ High impedance and excellent frequency characteristic.
- ◆ Low magnetic flux leakage. gineers with its impedance characteristics.

APPLICATIONS

- ◆ Power switching, TV game, Monitor , Car recharger , etc.
- ◆ Design as Customers Requested Specifications.



SHAPES AND DIMENSIONS (UNIT: mm)

LFU09V SHAPE

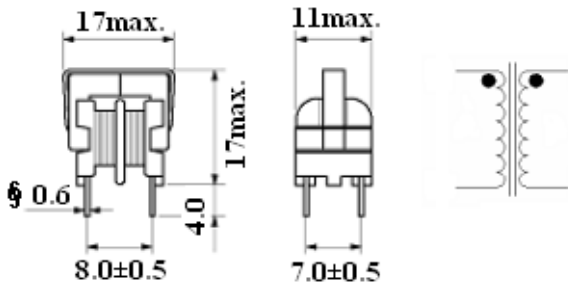

LFU09H SHAPE

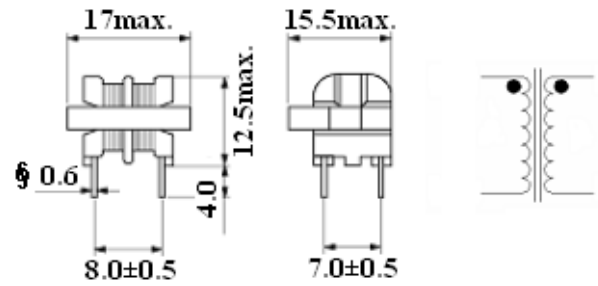

LFU10V SHAPE

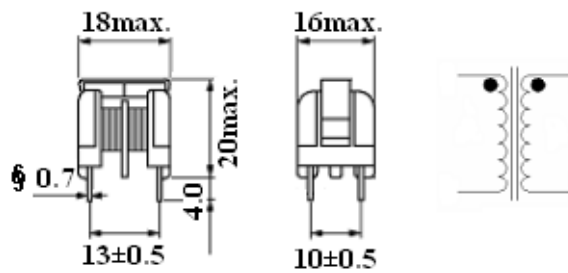

LFU10H SHAPE

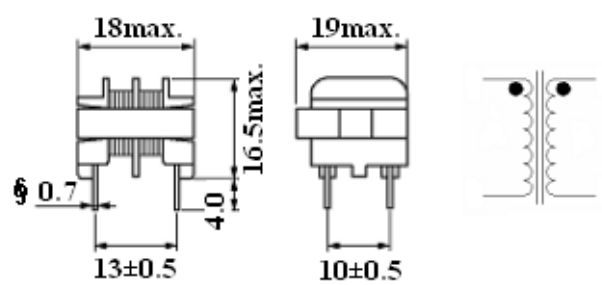

LFU16V SHAPE

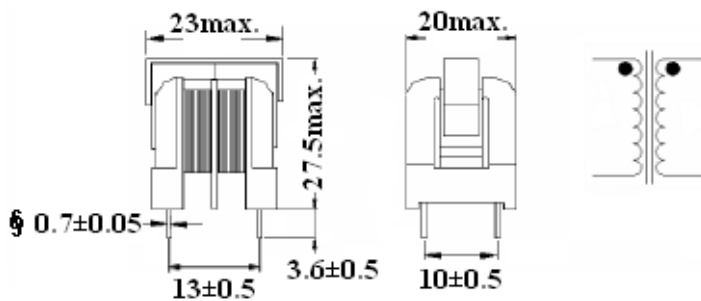

CORE MASTER ENTERPRISE CO., LTD.



<http://www.coremaster.com.tw>

LINE FILTERS / LFU TYPE

ELECTRICAL CHARACTERISTICS

Part No.	Inductance (mH)	DC Resistance (Ω)	Rated Current (A)
LFU 09 H LFU 09 V	0.5 - 10	0.30 - 8.0	0.1 - 1.0
LFU 10 H LFU 10 V	0.6 - 10	0.15 - 3.0	0.3 - 2.0
LFU 16 V	1.5 - 30	0.15 - 2.8	0.4 - 1.5

***DESIGN AS CUSTOMER'S REQUESTED SPECIFICATIONS**



CORE MASTER ENTERPRISE CO., LTD.

<http://www.coremaster.com.tw>

RADIAL CHOKE INDUCTORS / RC TYPE

FEATURES

- ◆ High rated current for high current circuits. Designed by special lead wire to prevent open circuit failure.
- ◆ Low cost with rugged reliability and performance fixed inductor.



APPLICATIONS

- ◆ Excellent as DC-DC converter boost or buck inductors. Also used for filtering applications.

ORDERING CODE

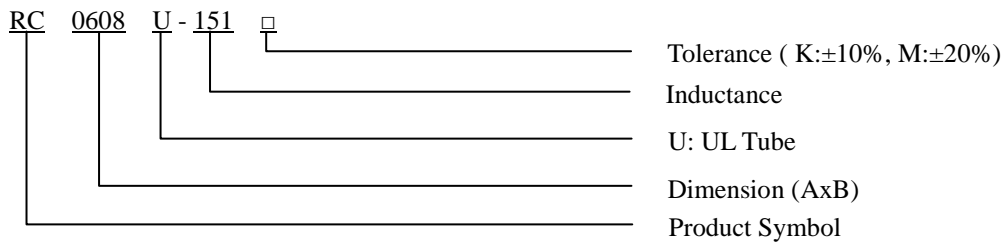

SHAPES

(WITHOUT TUBE)

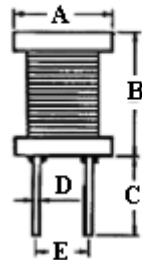

(WITH UL TUBE)

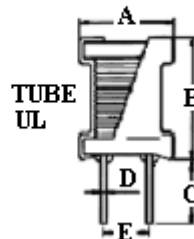

DIMENSIONS UNIT: mm (WITH ULTUBE)

Part No.	A (Max)	B (Max)	C (±2)	D (Typ)	E (Ref.)
RC 0406	6.0	8.0	15	0.50	2.0
RC 0608	8.0	11.0	15	0.60	3.0
RC 0810	10.0	13.0	15	0.65	5.0
RC 0912	11.0	15.0	15	0.80	5.0
RC 1012	12.5	15.0	15	0.80	6.0
RC 1016	12.5	19.0	15	0.80	6.0

***DESIGN AS CUSTOMER'S REQUESTED SPECIFICATIONS**



CORE MASTER ENTERPRISE CO., LTD.

<http://www.coremaster.com.tw>

SHIELDED RADIAL CHOKE INDUCTORS / SRC TYPE

FEATURES

- ◆ Low distortion.
- ◆ Ferrite Shielded.



APPLICATIONS

- ◆ Magnetically shielded construction.
- ◆ Ideally Used in Printers, LCD TV, DVD, Printer, Copy Machine, Main board of the compounding machines, etc as Power Supplies's Inductors or DC-DC Converter inductors.

ORDERING CODE

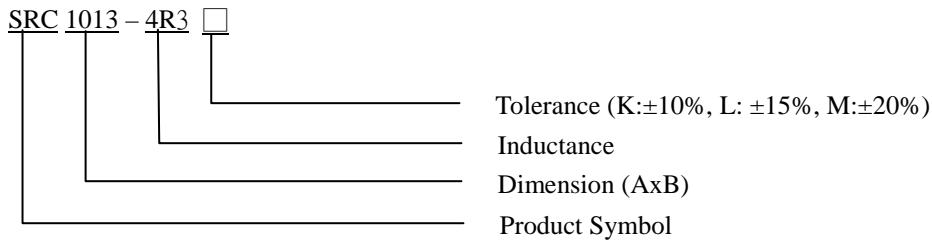

SHAPES

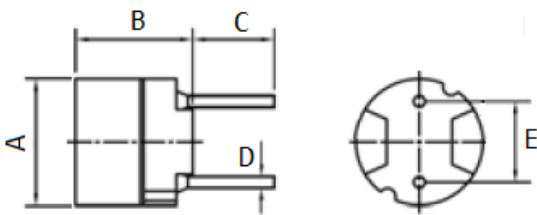

Fig. 1

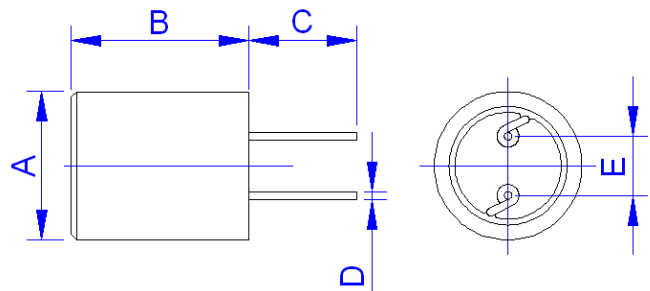

Fig. 2

DIMENSIONS UNIT: mm

Part No.	Fig.	A (MAX)	B (MAX)	C (REF)	D (REF)	E (REF)
SRC0606	1	6.5	7.0	5.0	0.5	4.0
SRC0807	1	8.3	7.8	5.0	0.6	5.0
SRC1013	2	11	14.5	5.0	0.7	5.0
SRC1317	2	14	18.5	5.0	0.7	5.0
SRC1616	2	17	17.5	5.0	0.8	7.5
SRC1619	2	17	20.5	5.0	1.0	7.5

*DESIGN AS CUSTOMER'S REQUESTED SPECIFICATIONS

CORE MASTER ENTERPRISE CO., LTD.



<http://www.coremaster.com.tw>

SMD COMMON MODE EMI FILTER / WCB TYPE

FEATURES

- Miniature SMD type common mode filter for fully automated assembly.
- Wide impedance range (25Ω~2200Ω) for noise suppression.
- Excellent Solderability.



ORDERING CODE

WCB 2012 - 900 Y-N

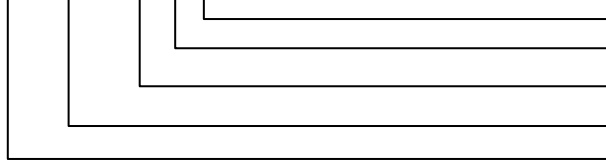

- Note: lead-free
- Tolerance (Y:±25%)
- Impedance
- Dimension (AxB)
- SMD Common Mode

SHAPES

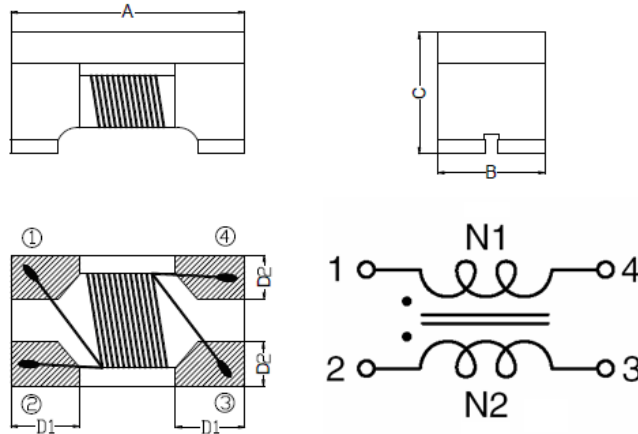

DIMENSIONS (UNIT: mm)

Part No.	A (±0.2)	B (±0.2)	C (±0.2)	D1 (Ref.)	D2 (Ref.)
WCB 2012	2.00	1.20	1.20	0.55	0.46
WCB 3216	3.20	1.60	2.00	0.50	0.50



CORE MASTER ENTERPRISE CO., LTD.

<http://www.coremaster.com.tw>

SMD COMMON MODE EMI FILTER / WCB TYPE

ELECTRICAL CHARACTERISTICS FOR WCB2012

Part No.	Impedance (Ω)100MHz	DC Resistance (Ω) Max	Rated Current (mA)Max
WCB 2012-250Y-N	25	0.20	500
WCB 2012-300Y-N	30	0.20	450
WCB 2012-400Y-N	40	0.20	450
WCB 2012-420Y-N	42	0.20	450
WCB 2012-500Y-N	50	0.25	450
WCB 2012-670Y-N	67	0.25	400
WCB 2012-750Y-N	75	0.35	330
WCB 2012-900Y-N	90	0.35	330
WCB 2012-101Y-N	100	0.35	330
WCB 2012-121Y-N	120	0.35	330
WCB 2012-161Y-N	160	0.35	300
WCB 2012-181Y-N	180	0.35	300
WCB 2012-201Y-N	200	0.35	300
WCB 2012-221Y-N	220	0.40	300
WCB 2012-261Y-N	260	0.40	300
WCB 2012-301Y-N	300	0.50	280
WCB 2012-331Y-N	330	0.50	280
WCB 2012-361Y-N	360	0.50	280
WCB 2012-371Y-N	370	0.50	250
WCB 2012-391Y-N	390	0.80	250
WCB 2012-501Y-N	500	0.80	250
WCB 2012-601Y-N	600	0.88	250
WCB 2012-801Y-N	800	0.88	250
WCB 2012-921Y-N	920	0.95	160
WCB 2012-222Y-N	2200	1.40	100

ELECTRICAL CHARACTERISTICS FOR WCB3216

Part No.	Impedance (Ω)100MHz	DC Resistance (Ω) Max	Rated Current (mA)Max
WCB 3216-900Y-N	90	0.30	400
WCB 3216-161Y-N	160	0.35	350
WCB 3216-221Y-N	220	0.45	300

CORE MASTER ENTERPRISE CO., LTD.



<http://www.coremaster.com.tw>

SMD COMMON MODE TOROIDS COILS / SFT TYPE

FEATURES

- ◆ Reduced components height
- ◆ High rated currents
- ◆ Suitable for reflow soldering
- ◆ RoHS-compatible



APPLICATIONS

- ◆ Automotive applications
- ◆ Industrial applications
- ◆ Telecom applications

ORDERING CODE

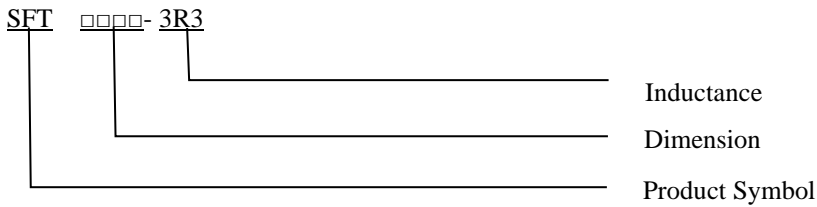

SHAPES

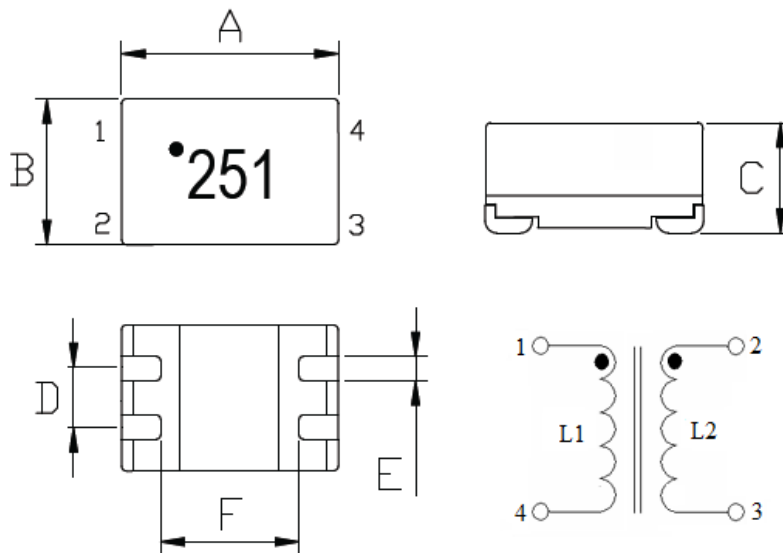

DIMENSIONS (UNIT: mm)

Part No.	A	B	C	D	E	F
SFT0905	9.2 ± 0.3	6.0 ± 0.3	5.0 ± 0.3	2.54 ± 0.3	1.0 (REF)	5.7 (REF)



CORE MASTER ENTERPRISE CO., LTD.

<http://www.coremaster.com.tw>

SMD COMMON MODE TOROIDS COILS / SFT TYPE

ELECTRICAL CHARACTERISTICS FOR SFT0905

Part No.	Inductance L1=L2 (uH)	Test Frequency (KHz)	RDC RDC1=RDC2 (mΩ) MAX	IDC (A) MAX
SFT0905-100□	10 ±50%	1KHz / 0.1V	80	1.6
SFT0905-250□	25 ±50%	1KHz / 0.1V	120	1.3
SFT0905-400□	40 ±50%	1KHz / 0.1V	120	1.3
SFT0905-510□	51 ±50%	1KHz / 0.1V	120	1.3
SFT0905-251□	250 ± 50%	100KHz / 0.05V	130	1.2
SFT0905-501□	500 ± 50%	100KHz / 0.05V	150	1.0
SFT0905-102□	1000 ± 50%	100KHz / 0.05V	310	0.8
SFT0905-202□	2000 ± 50%	100KHz / 0.05V	420	0.6
SFT0905-472□	4700 ± 50%	100KHz / 0.05V	900	0.4
SFT0905-652□	6500 ± 50%	100KHz / 0.05V	1050	0.3



CORE MASTER ENTERPRISE CO., LTD.

<http://www.coremaster.com.tw>

SMD COMMON MODE TOROIDS COILS / SHT TYPE

FEATURES

- ◆ Reduced components height
- ◆ High rated currents
- ◆ Suitable for reflow soldering
- ◆ RoHS-compatible



APPLICATIONS

- ◆ Automotive applications
- ◆ Industrial applications
- ◆ Telecom applications

ORDERING CODE

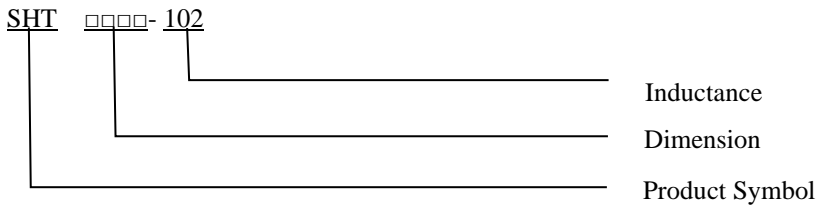

SHAPES

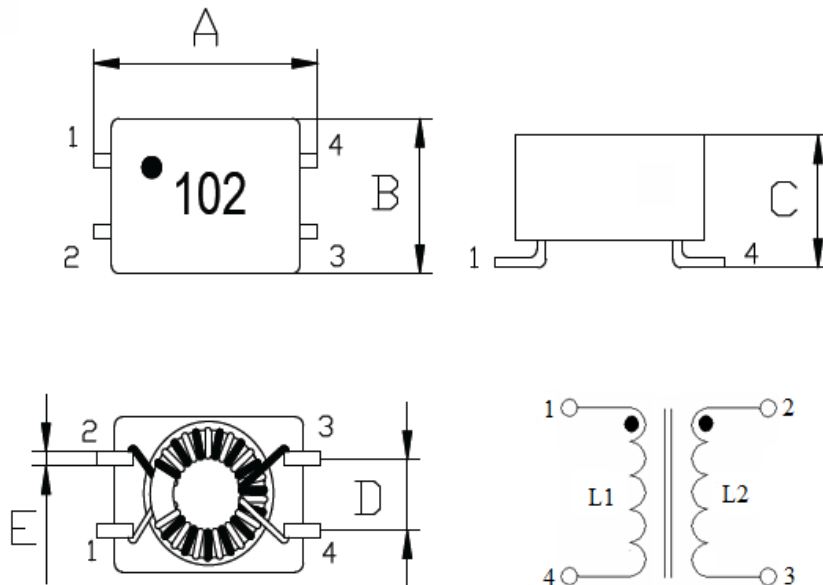

DIMENSIONS (UNIT: mm)

Part No.	A	B	C	D	E
SHT0905	9.0 ± 0.5	5.5 ± 0.4	5.2 (MAX)	2.54 ± 0.3	0.5 (REF)



CORE MASTER ENTERPRISE CO., LTD.

<http://www.coremaster.com.tw>

SMD COMMON MODE TOROIDS COILS / SHT TYPE

ELECTRICAL CHARACTERISTICS FOR SHT0905

Part No.	Inductance L1=L2 (μ H)	Test Frequency (KHz)	RDC RDC1=RDC2 ($m\Omega$) MAX	IDC (A) MAX
SHT0905-110 □	11 \pm 50%	100KHz / 0.1V	120	1.0
SHT0905-250 □	25 \pm 50%	100KHz / 0.1V	120	0.9
SHT0905-510 □	51 \pm 50%	100KHz / 0.1V	195	0.8
SHT0905-101 □	100 \pm 50%	100KHz / 0.1V	250	0.7
SHT0905-471 □	470 \pm 50%	100KHz / 0.1V	280	0.7
SHT0905-102 □	1000 \pm 50%	100KHz / 0.1V	300	0.7
SHT0905-222 □	2200 \pm 50%	100KHz / 0.1V	400	0.5
SHT0905-472 □	4700 \pm 50%	100KHz / 0.1V	700	0.4



CORE MASTER ENTERPRISE CO., LTD.

<http://www.coremaster.com.tw>

WOUND TOROIDS COILS / TC TYPE

APPLICATIONS

- ◆ Other filters
- ◆ Power supplies
- ◆ Out put chokes
- ◆ EMI/RFI chokes
- ◆ Switching Circuits
- ◆ SCR and Triac Controls



ORDERING CODE

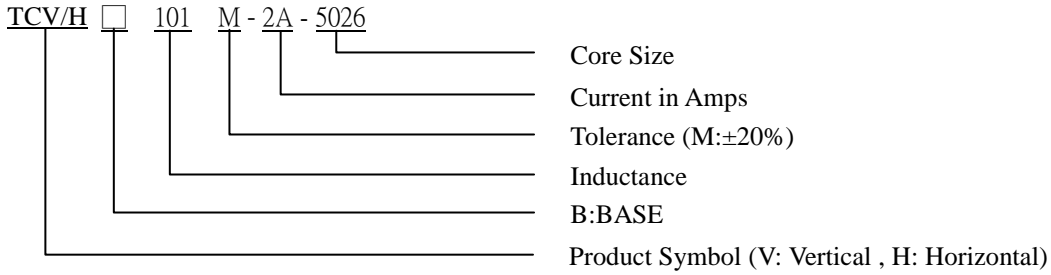

SHAPES

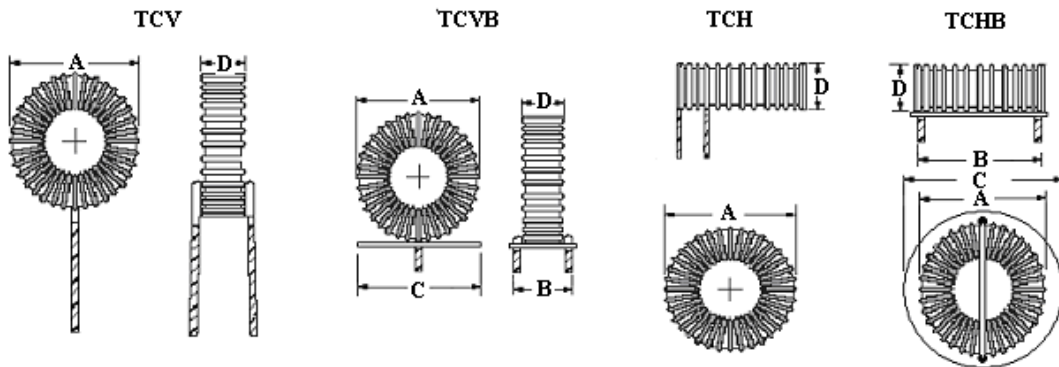

DIMENSIONS (UNIT: mm)

Part No.	A (Max)	B (Max)	C (Max)	D (Max)
TCV	7.5 ~ 42.5			5.5 ~ 21.5
TCVB	12.0 ~ 39.0	10 ~ 20	11 ~ 30	7.0 ~ 18.5
TCH	7.5 ~ 42.5			5.5 ~ 21.5
TCHB	12.0 ~ 39.0	9 ~ 36	13 ~ 42	7.0 ~ 18.5

*DESIGN AS CUSTOMER'S REQUESTED SPECIFICATIONS



CORE MASTER ENTERPRISE CO., LTD.

<http://www.coremaster.com.tw>

EMI BEADS (DIP) / RHWT TYPE

FEATURES

- ◆ Employ high performance ferrites with superior frequency characteristics.

APPLICATIONS

- ◆ Prevent spike noise
- ◆ Prevent intrusion and radiation of unnecessary signals into the clock pulse oscillation section and various interfaces, except those for RGB and composite signals.



ORDERING CODE

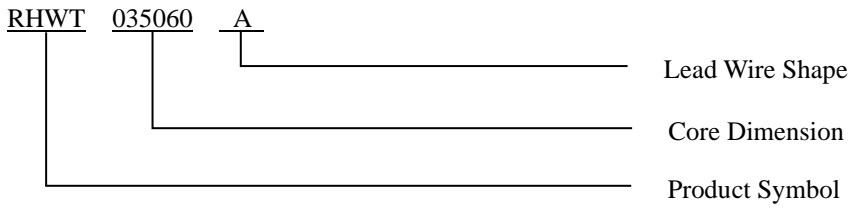

LEAD WIRE SHAPE & TAPING SHAPE (UNIT: mm)

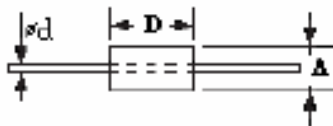

Fig. A

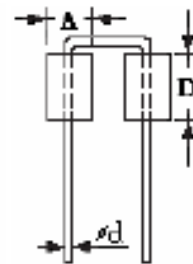
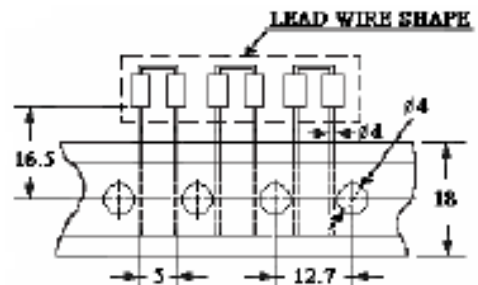
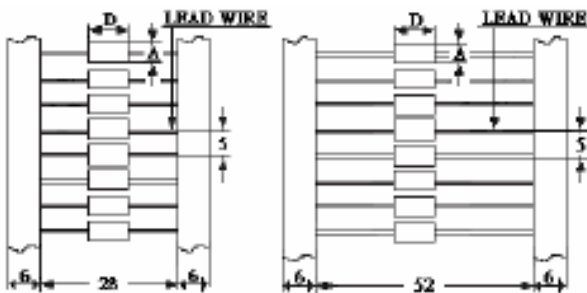

Fig. B



CORE MASTER ENTERPRISE CO., LTD.

<http://www.coremaster.com.tw>

EMI BEADS (DIP) / RHWT TYPE

DIMENSIONS (UNIT: mm)

PartNo.	Fig.	A	D	Φd (±0.05)	Impedance (Ω) Min	
					25MHz	100MHz
RHWT 025030	A	2.5 ±0.2	3.0 ±0.3	0.65	20	40
RHWT 025045		2.5 ±0.2	4.5 ±0.3	0.65	30	50
RHWT 035030		3.5 ±0.2	3.0 ±0.3	0.65	20	40
RHWT 035045		3.5 ±0.2	4.5 ±0.3	0.65	35	60
RHWT 035050		3.5 ±0.2	5.0 ±0.3	0.65	35	60
RHWT 035060		3.5 ±0.2	6.0 ±0.3	0.65	40	70
RHWT 035080		3.5 ±0.2	8.0 ±0.3	0.65	45	70
RHWT 035090		3.5 ±0.2	9.0 ±0.3	0.65	55	90
RHWT 035045X2		B	3.5 ±0.2	4.5 ±0.3	0.65	60
RHWT 035050X2	3.5 ±0.2		5.0 ±0.3	0.65	65	110
RHWT 035060X2	3.5 ±0.2		6.0 ±0.3	0.65	70	130



CORE MASTER ENTERPRISE CO., LTD.

<http://www.coremaster.com.tw>

FLAT CABLE EMI CORES / FP TYPE

APPLICATIONS

- ◆ Internal floppy disk and harddisk ribbon cables
- ◆ Internal ribbon cables between circuit boards and data connectors
- ◆ Internal ribbon cables with series digital signal busses



MATERIAL

B8 B10 B15

ORDERING CODE

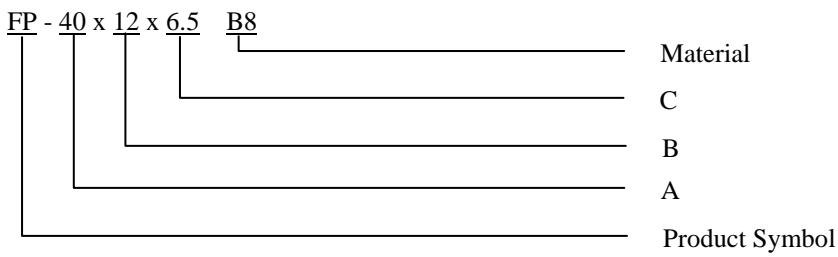

SHAPES

Fig.1

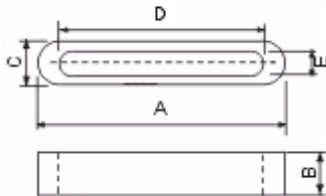
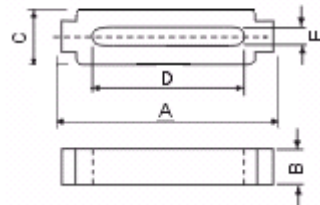

Fig.2



CORE MASTER ENTERPRISE CO., LTD.

<http://www.coremaster.com.tw>



FLAT CABLE EMI CORES / FP TYPE

DIMENSIONS (UNIT: mm)

Part No.	Fig.	Dimension				
		A	B	C	D	E
FP-12X19X9	1	12.0 ± 0.3	19.0 ± 0.5	9.0 ± 0.3	7.5 ± 0.3	4.5 ± 0.3
FP-13.5X6X2	1	13.5 ± 0.3	6.0 ± 0.3	2.0 ± 0.3	11.0 ± 0.3	0.5+0.4-0
FP-16X8X5	1	16.0+0.2-0.5	8.0 ± 0.3	5.0+0-0.6	11.5+0.5-0.1	0.5+0.5-0
FP-18X8X5	1	18.0 ± 1.0	8.0 ± 0.5	5.0 ± 0.3	14.0 ± 0.5	1.0 ± 0.5
FP-19X6X6.5	1	19.0 ± 0.8	6.0 ± 0.5	6.5 ± 0.3	13.5 ± 0.6	1.5 ± 0.3
FP-19X12X6.5	1	19.0 ± 0.8	12.0 ± 0.5	6.5 ± 0.3	13.5 ± 0.6	1.5 ± 0.3
FP-23.8X12.5X6.3	1	23.8 ± 0.7	12.5 ± 0.5	6.3 ± 0.5	18.4 ± 0.5	1.1 ± 0.3
FP-23.8X12.5X6.5	1	23.8 ± 1.0	12.5 ± 0.6	6.5 ± 0.5	18.5 ± 0.7	1.5 ± 0.5
FP-25X12X5	1	25.0 ± 0.8	12.0 ± 0.5	5.0 ± 0.4	21.0 ± 0.7	1.2 ± 0.3
FP-28X10X7.7	2	28.0 ± 0.8	10.0 ± 0.4	7.7 ± 0.4	23.0 ± 0.5	1.4 ± 0.2
FP-28X14.6X7.7	2	28.0 ± 0.8	14.6 ± 0.4	7.7 ± 0.3	23.0 ± 0.5	1.4 ± 0.3
FP-29X10X8	1	29.0 ± 0.8	10.0 ± 0.5	8.0 ± 0.5	22.0 ± 0.8	2.5 ± 0.4
FP-31X12X5	1	31.0 ± 0.8	12.0 ± 0.5	5.0 ± 0.3	27.0 ± 0.8	0.5+0.7-0.1
FP-33.5X12X6.5	1	33.5 ± 1.0	12.0 ± 0.5	6.5 ± 0.5	27.5 ± 1.0	1.5 ± 0.5
FP-40X12X6.5	1	40.0 ± 1.2	12.0 ± 0.5	6.5 ± 0.3	33.5 ± 1.5	1.5 ± 0.3
FP-41X15X7.7	1	41.0 ± 1.2	15.0 ± 0.4	7.7 ± 0.4	34.5 ± 1.2	1.8 ± 0.4
FP-49.6X12X6.5	1	49.6 ± 1.5	12.0 ± 0.4	6.5 ± 0.5	43.0 ± 1.0	1.5 ± 0.5
FP-57.9X12X7	1	57.9 ± 0.7	12.0 ± 0.3	7.0 ± 0.3	52.0 +1.0-0.2	1.3 + 0.6-0

CORE MASTER ENTERPRISE CO., LTD.



<http://www.coremaster.com.tw>

NI-ZN EMI BEAD CORES / RH TYPE

FEATURES

- ◆ Easy installation
- ◆ Compact and high performance



APPLICATIONS

- ◆ Countermeasures against radiated emissions
- ◆ For full compliance with FCC regulations and VCCI
- ◆ Improvement of noise immunity of personal computers, microcomputers, peripheral and relative devices

MATERIAL

B8 B10 B15 B18

ORDERING CODE

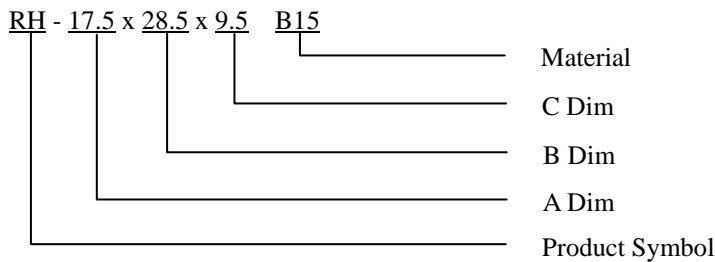

SHAPES

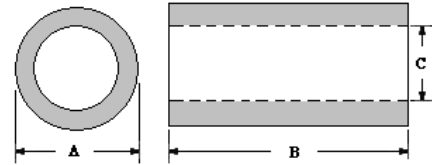

DIMENSIONS (Unit: mm)

Cores	A	B	C
RH-2.3 x 4.5 x 0.8	2.30 ± 0.15	4.50 ± 0.30	0.80 ± 0.15
RH-3 x 3 x 0.8	3.00 ± 0.15	3.00 ± 0.20	0.80 ± 0.15
RH-3 x 4 x 1	3.00 ± 0.15	4.00 ± 0.30	1.00 ± 0.15
RH-3.5 x 8.9 x 0.8	3.50 ± 0.15	8.90 ± 0.30	0.80 ± 0.15
RH-3.5 x 12 x 1.2	3.50 ± 0.15	12.00 ± 0.40	1.20 ± 0.15
RH-3.5 x 10 x 1.5	3.50 ± 0.15	10.00 ± 0.40	1.50 ± 0.15
RH-3.5 x 13.8 x 0.8	3.50 ± 0.15	13.80 ± 0.40	0.80 ± 0.15
RH-3.8 x 8 x 1.8	3.80 ± 0.15	8.00 ± 0.40	1.80 ± 0.15
RH-4 x 5 x 2	4.00 ± 0.20	5.00 ± 0.30	2.00 ± 0.15
RH-4 x 20 x 2	4.00 ± 0.20	20.00 ± 0.50	2.00 ± 0.15
RH-4.1 x 10 x 1.6	4.10 ± 0.20	10.00 ± 0.40	1.60 ± 0.15
RH-5 x 10 x 1.5	5.00 ± 0.30	10.00 ± 0.40	1.50 ± 0.15
RH-6 x 10 x 3	6.00 ± 0.30	10.00 ± 0.40	3.00 ± 0.20
RH-6.5 x 10 x 4.3	6.50 ± 0.30	10.00 ± 0.40	4.30 ± 0.20
RH-7 x 20 x 4	7.00 ± 0.30	20.00 ± 0.50	4.00 ± 0.25
RH-7.5 x 19 x 2.8	7.50 ± 0.30	19.00 ± 0.50	2.80 ± 0.20
RH-7.75 x 19 x 4	7.75 ± 0.30	19.00 ± 0.50	4.00 ± 0.25
RH-8 x 18 x 3	8.00 ± 0.30	18.00 ± 0.50	3.00 ± 0.20
RH-8 x 9.2 x 4	8.00 ± 0.30	9.20 ± 0.30	4.00 ± 0.25
RH-8 x 20 x 5.6	8.00 ± 0.30	20.00 ± 0.60	5.60 ± 0.25
RH-9 x 16 x 5	9.00 ± 0.30	16.00 ± 0.50	5.00 ± 0.25
RH-9.5 x 18.2 x 2.8	9.50 ± 0.30	18.20 ± 0.50	2.80 ± 0.20
RH-9.5 x 10 x 5	9.50 ± 0.30	10.00 ± 0.40	5.00 ± 0.25
RH-9.8 x 14 x 5.6	9.80 ± 0.30	14.00 ± 0.50	5.60 ± 0.25
RH-9.8 x 25 x 7	9.80 ± 0.30	25.00 ± 0.70	7.00 ± 0.30

CORE MASTER ENTERPRISE CO., LTD.



<http://www.coremaster.com.tw>

NI-ZN EMI BEAD CORES / RH TYPE

DIMENSIONS (Unit: mm)

Cores	A	B	C
RH-10 x 10 x 5	10.00 ± 0.40	10.00 ± 0.40	5.00 ± 0.25
RH-10.5 x 20 x 5.6	10.50 ± 0.40	20.00 ± 0.60	5.60 ± 0.25
RH-10.5 x 20 x 6	10.50 ± 0.40	20.00 ± 0.60	6.00 ± 0.30
RH-11.5 x 18 x 5.2	11.50 ± 0.40	18.00 ± 0.50	5.20 ± 0.25
RH-11.5 x 25 x 7.1	11.50 ± 0.40	25.00 ± 0.70	7.10 ± 0.30
RH-12 x 25 x 4	12.00 ± 0.40	25.00 ± 0.70	4.00 ± 0.25
RH-12 x 25.6 x 5.2	12.00 ± 0.40	25.60 ± 0.70	5.20 ± 0.25
RH-12 x 20 x 6.35	12.00 ± 0.40	20.00 ± 0.60	6.35 ± 0.30
RH-12 x 25 x 7.1	12.00 ± 0.40	25.00 ± 0.70	7.10 ± 0.30
RH-12 x 28 x 7.3	12.00 ± 0.40	28.00 ± 0.70	7.30 ± 0.30
RH-12.5 x 20 x 4.9	12.50 ± 0.40	20.00 ± 0.60	4.90 ± 0.30
RH-12.7 x 15 x 7.88	12.70 ± 0.40	15.00 ± 0.50	7.88 ± 0.30
RH-13 x 15.2 x 5.5	13.00 ± 0.40	15.20 ± 0.50	5.50 ± 0.25
RH-13 x 26 x 5.6	13.00 ± 0.40	26.00 ± 0.70	5.60 ± 0.30
RH-13 x 25.4 x 9.4	13.00 ± 0.40	25.40 ± 0.70	9.40 ± 0.30
RH-14 x 28.5 x 5.2	14.00 ± 0.50	28.50 ± 0.70	5.20 ± 0.25
RH-14.27 x 23.5 x 6.35	14.27 ± 0.50	23.50 ± 0.60	6.35 ± 0.30
RH-14.27x 28.5 x 6.35	14.27 ± 0.50	28.50 ± 0.70	6.35 ± 0.30
RH-14.27 x 15 x 7	14.27 ± 0.50	15.00 ± 0.50	7.00 ± 0.30
RH-14.27 x 28 x 7	14.27 ± 0.50	28.00 ± 0.70	7.00 ± 0.30
RH-14.27 x 23.5 x 7.88	14.27 ± 0.50	23.50 ± 0.60	7.88 ± 0.30
RH-14.27 x 23.5 x 8.3	14.27 ± 0.50	23.50 ± 0.60	8.30 ± 0.30
RH-14.27 x 28.5 x 9.15	14.27 ± 0.50	28.50 ± 0.70	9.15 ± 0.30
RH-15 x 28.5 x 7.3	15.00 ± 0.50	28.50 ± 0.70	7.30 ± 0.30
RH-15.25 x 28.5 x 8	15.25 ± 0.50	28.50 ± 0.70	8.00 ± 0.30
RH-15.8 x 28.5 x 7.88	15.80 ± 0.50	28.50 ± 0.70	7.88 ± 0.30
RH-16 x 17 x 4.5	16.00 ± 0.50	17.00 ± 0.50	4.50 ± 0.25
RH-16 x 16 x 7.88	16.00 ± 0.50	16.00 ± 0.50	7.88 ± 0.30
RH-16 x 17 x 9.15	16.00 ± 0.50	17.00 ± 0.50	9.15 ± 0.30
RH-16 x 30 x 9.15	16.00 ± 0.50	30.00 ± 1.00	9.15 ± 0.30
RH-16 x 28.5 x 9.5	16.00 ± 0.50	28.50 ± 1.00	9.50 ± 0.30
RH-16 x 28 x 11	16.00 ± 0.50	28.00 ± 0.70	11.00 ± 0.40
RH-17 x 25 x 4	17.00 ± 0.50	25.00 ± 0.70	4.00 ± 0.30
RH-17.2 x 25 x 7	17.20 ± 0.50	25.00 ± 0.70	7.00 ± 0.30
RH-17.5 x 27 x 8	17.50 ± 0.50	27.00 ± 0.70	8.00 ± 0.30
RH-17.5 x 28.5 x 8	17.50 ± 0.50	28.50 ± 0.70	8.00 ± 0.30
RH-17.5 x 28.5 x 9.5	17.50 ± 0.50	28.50 ± 0.70	9.50 ± 0.30
RH-17.5 x 35 x 9.5	17.50 ± 0.50	35.00 ± 1.00	9.50 ± 0.30
RH-17.5 x 28.5 x 10.6	17.50 ± 0.50	28.50 ± 0.70	10.60 ± 0.40
RH-17.5 x 28.5 x 11	17.50 ± 0.50	28.50 ± 0.70	11.00 ± 0.40
RH-18.2 x 28.5 x 9.5	18.20 ± 0.50	28.50 ± 0.70	9.50 ± 0.30
RH-18.4 x 28.5 x 10.2	18.40 ± 0.50	28.50 ± 0.70	10.20 ± 0.40
RH-18.4 x 50.8 x 11	18.40 ± 0.50	50.80 ± 1.00	11.00 ± 0.40
RH-18.4 x 28.5 x 12.5	18.40 ± 0.50	28.50 ± 0.70	12.50 ± 0.40
RH-19.7 x 28.5 x 11.7	19.70 ± 0.50	28.50 ± 0.70	11.70 ± 0.40
RH-25.9 x 28 x 10.2	25.90 ± 0.60	28.00 ± 0.70	10.20 ± 0.40
RH-26 x 28.5 x 12.8	26.00 ± 0.60	28.50 ± 0.70	12.80 ± 0.50
RH-26 x 28.5 x 16	26.00 ± 0.60	28.50 ± 0.70	16.00 ± 0.50
RH-28 x 28.5 x 16	28.00 ± 0.70	28.50 ± 0.70	16.00 ± 0.50

CORE MASTER ENTERPRISE CO., LTD.



<http://www.coremaster.com.tw>

NI-ZN TOROID CORES / T TYPE

FEATURES

- ◆ Minimal effect on transmission waveforms
- ◆ Can be added as First-Aid, On-The Spot countermeasures when equipment or devices fail



APPLICATIONS

- ◆ Equipment using sensors
- ◆ TVs, FM/AM Tuners, VTRs/VCRs
- ◆ Harness noise countermeasures for automobiles Computers, NC machines, and Plain paper copiers
- ◆ Measuring equipment, OA equipment, terminal equipment and ISDN terminal equipment

MATERIAL

B8 B10 B12 B15

ORDERING CODE

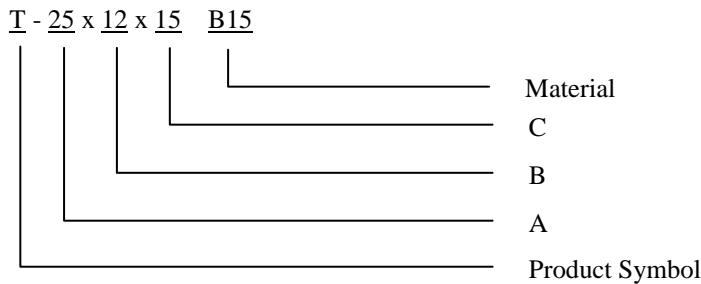

SHAPES

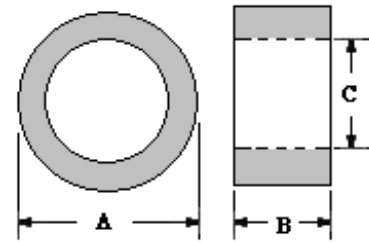

DIMENSIONS (Unit: mm)

Cores	A	B	C
T-2.5 x 1.2 x 1	2.50 ± 0.15	1.20 ± 0.20	1.00 ± 0.15
T-3.3 x 2 x 2.58	3.30 ± 0.15	2.00 ± 0.25	2.58 ± 0.15
T-3.5 x 2 x 0.85	3.50 ± 0.15	2.00 ± 0.20	0.85 ± 0.15
T-3.5 x 3.1 x 1.2	3.50 ± 0.15	3.10 ± 0.30	1.20 ± 0.15
T-4 x 1 x 2	4.00 ± 0.20	1.00 ± 0.20	2.00 ± 0.20
T-4.5 x 2 x 1.5	4.50 ± 0.20	2.00 ± 0.20	1.50 ± 0.15
T-4.8 x 3 x 2.8	4.80 ± 0.20	3.00 ± 0.30	2.80 ± 0.20
T-6 x 4 x 3	6.00 ± 0.30	4.00 ± 0.30	3.00 ± 0.20
T-6 x 5 x 2	6.00 ± 0.30	5.00 ± 0.30	2.00 ± 0.20
T-6.5 x 5 x 3.3	6.50 ± 0.30	5.00 ± 0.30	3.30 ± 0.20
T-7.75 x 3 x 4	7.75 ± 0.30	3.00 ± 0.30	4.00 ± 0.20
T-8 x 3 x 4	8.00 ± 0.30	3.00 ± 0.30	4.00 ± 0.20
T-8 x 7 x 5.6	8.00 ± 0.30	7.00 ± 0.30	5.60 ± 0.20
T-9 x 3 x 5	9.00 ± 0.30	3.00 ± 0.30	5.00 ± 0.30
T-9.5 x 3.5 x 4.8	9.50 ± 0.30	3.50 ± 0.30	4.80 ± 0.20
T-9.66 x 3.7 x 4.9	9.66 ± 0.30	3.70 ± 0.30	4.90 ± 0.30
T-9.66 x 7.35 x 6.35	9.66 ± 0.30	7.35 ± 0.30	6.35 ± 0.30
T-9.8 x 7.35 x 6.35	9.80 ± 0.30	7.35 ± 0.30	6.35 ± 0.30

NI-ZN TOROID CORES / T TYPE

Cores	A	B	C
T-10 x 6 x 4	10.00 ± 0.30	6.00 ± 0.30	4.00 ± 0.20
T-10 x 4 x 6	10.00 ± 0.30	4.00 ± 0.30	6.00 ± 0.30
T-10 x 10 x 5	10.00 ± 0.30	10.0 ± 0.40	5.00 ± 0.30
T-10.3 x 10.2 x 5.8	10.30 ± 0.30	10.2 ± 0.40	5.80 ± 0.30
T-12 x 6 x 4	12.00 ± 0.40	6.00 ± 0.30	4.00 ± 0.20
T-12 x 4 x 6	12.00 ± 0.40	4.00 ± 0.30	6.00 ± 0.30
T-12 x 10 x 6.5	12.00 ± 0.40	10.0 ± 0.40	6.50 ± 0.30
T-12 x 11 x 8.6	12.00 ± 0.40	11.0 ± 0.40	8.60 ± 0.30
T-12.7 x 6.35 x 7.9	12.70 ± 0.40	6.35 ± 0.40	7.90 ± 0.30
T-12.7 x 12.5 x 7.88	12.70 ± 0.40	12.5 ± 0.40	7.88 ± 0.30
T-13 x 8 x 8.2	13.00 ± 0.40	8.00 ± 0.30	8.20 ± 0.30
T-13.5 x 5 x 7	13.50 ± 0.40	5.00 ± 0.30	7.00 ± 0.30
T-14.2 x 5 x 6.35	14.20 ± 0.50	5.00 ± 0.30	6.35 ± 0.30
T-14.2 x 5 x 9.15	14.20 ± 0.50	5.00 ± 0.30	9.15 ± 0.30
T-14.2 x 10 x 7.45	14.20 ± 0.50	10.0 ± 0.40	7.45 ± 0.30
T-14.2 x 5 x 8.3	14.27 ± 0.50	5.00 ± 0.30	8.30 ± 0.30
T-14.2 x 13.5 x 6.35	14.27 ± 0.50	13.5 ± 0.40	6.35 ± 0.30
T-15.2 x 12.7 x 10.2	15.20 ± 0.50	12.7 ± 0.40	10.2 ± 0.30
T-16 x 12 x 8	16.00 ± 0.50	12.0 ± 0.40	8.00 ± 0.30
T-16 x 12 x 9.15	16.00 ± 0.50	12.0 ± 0.40	9.15 ± 0.30
T-16 x 10 x 8	16.00 ± 0.50	10.0 ± 0.40	8.00 ± 0.30
T-16 x 16 x 7.88	16.00 ± 0.50	16.0 ± 0.50	7.88 ± 0.30
T-17.5 x 6.8 x 10.6	17.50 ± 0.50	6.80 ± 0.30	10.6 ± 0.30
T-17.5 x 12.7 x 10.2	17.50 ± 0.50	12.7 ± 0.40	10.2 ± 0.30
T-18.4 x 9.5 x 12.5	18.40 ± 0.50	9.50 ± 0.30	12.5 ± 0.40
T-20 x 4 x 5.2	20.00 ± 0.50	4.00 ± 0.30	5.20 ± 0.30
T-20 x 10 x 10.2	20.00 ± 0.50	10.0 ± 0.40	10.2 ± 0.30
T-20 x 14.2 x 5.2	20.00 ± 0.50	14.2 ± 0.40	5.20 ± 0.30
T-21.2 x 6 x 12.7	21.20 ± 0.50	6.00 ± 0.30	12.7 ± 0.40
T-22.5 x 6 x 13.8	22.50 ± 0.50	6.00 ± 0.30	13.8 ± 0.50
T-23 x 6.4 x 12.5	23.00 ± 0.50	6.40 ± 0.30	12.5 ± 0.40
T-23 x 9.5 x 12.5	23.00 ± 0.50	9.50 ± 0.30	12.5 ± 0.40
T-23 x 14 x 11	23.00 ± 0.50	14.0 ± 0.30	11.0 ± 0.40
T-24 x 14 x 11	24.00 ± 0.60	14.0 ± 0.40	11.0 ± 0.40
T-25 x 10 x 15	25.00 ± 0.60	10.0 ± 0.40	15.0 ± 0.50
T-25.9 x 14.09 x 17	25.90 ± 0.60	14.09 ± 0.40	17.0 ± 0.50
T-25.9 x 12.7 x 16	25.90 ± 0.60	12.7 ± 0.40	16.0 ± 0.50
T-28 x 3.75 x 5.2	28.00 ± 0.70	3.75 ± 0.30	5.20 ± 0.30
T-28 x 13.4 x 16	28.00 ± 0.70	13.40 ± 0.40	16.0 ± 0.50
T-28 x 19 x 16	28.00 ± 0.70	19.0 ± 0.50	16.0 ± 0.50
T-29 x 14 x 19	29.00 ± 0.70	14.0 ± 0.30	19.0 ± 0.50
T-31 x 7 x 19	31.00 ± 0.70	7.00 ± 0.30	19.0 ± 0.50
T-31 x 16 x 19	31.00 ± 0.70	16.0 ± 0.50	19.0 ± 0.50
T-36 x 12 x 23	36.00 ± 0.80	12.0 ± 0.40	23.0 ± 0.60
T-36 x 22 x 19	36.00 ± 0.80	22.0 ± 0.60	19.0 ± 0.50
T-37.5 x 5.5 x 9.1	37.50 ± 0.80	5.50 ± 0.30	9.10 ± 0.30
T-40 x 15 x 23.4	40.00 ± 0.80	15.0 ± 0.50	23.4 ± 0.60
T-40.6 x 15 x 27.5	40.60 ± 1.00	15.0 ± 0.40	27.5 ± 0.60
T-61.4 x 12.8 x 36	61.40 ± 1.30	12.8 ± 0.40	36.0 ± 0.80

CORE MASTER ENTERPRISE CO., LTD.



<http://www.coremaster.com.tw>

ROUND CABLE EMI CORES / LF TYPE

FEATURES

- ◆ Easy installation
- ◆ Internal dimensions are from 4mm to 19 mm diameter.
- ◆ The smooth surface prevents damage to wire insulation.



APPLICATIONS

- ◆ Internal and external power cables
- ◆ Internal cables between pc boards and data connectors
- ◆ Computer peripherals, for example digital camera, DVD, fax machine, monitor, printer, and power supply cables

ORDERING CODE

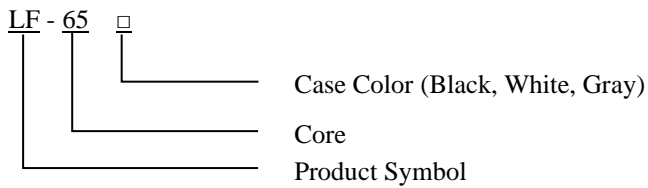

SHAPES

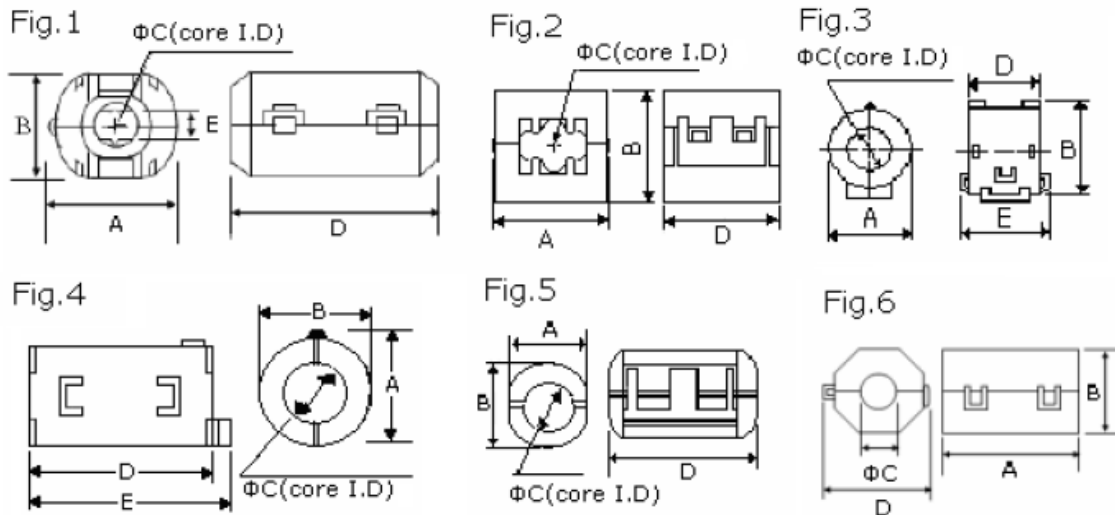

CORE MASTER ENTERPRISE CO., LTD.

<http://www.coremaster.com.tw>

ROUND CABLE EMI CORES / LF TYPE

DIMENSIONS (UNIT:mm)

Part No.	Fig.	A (±1)	B (±1)	C (±1)	D (±1)	E (±1)	Impedance (Ω) Min		Use Cable OD
							25 MHz	100 MHz	
LF-35	5	15.0	15.0	4.0	25.2	---	55	95	Φ4
LF-50	5	16.5	16.5	5.2	29.5	---	50	100	Φ5
LF-501	2	15.0	14.0	5.2	23.0	---	65	135	Φ5
LF-502	1	13.0	11.8	5.0	25.5	---	60	120	Φ5
LF-503	1	16.5	15.0	5.2	30.0	---	108	184	Φ5
LF-60	6	18.5	14.0	6.0	15.5	---	40	70	Φ6
LF-65	2	20.5	20.0	6.5	33.0	---	105	195	Φ6.5
LF-70	4	15.5	14.0	7.0	18.0	22.0	35	75	Φ7
LF-702	1	17.0	15.0	7.0	30.0	---	65	120	Φ7
LF-75	5	21.0	21.0	7.5	39.0	---	80	150	Φ7.5
LF-801	3	19.5	23.0	8.1	17.0	23.0	50	100	Φ8
LF-802	3	19.5	23.0	8.1	20.0	26.0	50	100	Φ8
LF-901	4	20.5	19.5	9.0	31.5	35.5	90	210	Φ9
LF-902	1	19.5	18.0	9.0	35.0	---	80	160	Φ9
CT-0933	1	20.9	20.9	9.3	41.8	---	105	190	Φ9
CT-0933-2B	1	22.0	23.5	9.3	43.0	---	100	180	Φ9
LF-100	2	25.5	23.5	10.0	33.0	---	100	200	Φ10
LF-101	3	24.5	28.5	10.2	13.5	20.0	30	70	Φ10
LF-102	1	21.5	20.0	10.0	35.0	---	80	140	Φ10
LF-110	4	20.5	21.0	11.0	32.0	36.0	80	130	Φ11
LF-120	3	28.0	32.0	11.5	18.0	24.0	45	100	Φ11.5
LF-130	2	31.5	30.0	13.0	33.0	---	105	170	Φ13
LF-1301	1	23.5	22.5	13.0	36.0	---	60	130	Φ13
LF-1302	4	31.5	30.5	13.0	34.0	39.0	80	130	Φ13
LF-150	3	29.0	33.0	15.0	15.5	21.5	30	75	Φ15
LF-190	2	29.2	29.4	19.4	42.0	---	80	160	Φ19



CORE MASTER ENTERPRISE CO., LTD.

<http://www.coremaster.com.tw>

SMD WIDE BAND CHOKES / MSH TYPE

APPLICATIONS

The wide band choke cores are mainly used in the PC boards to filters the EMI from the outsides.



ORDERING CODE

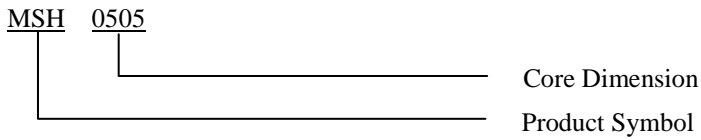

SHAPES

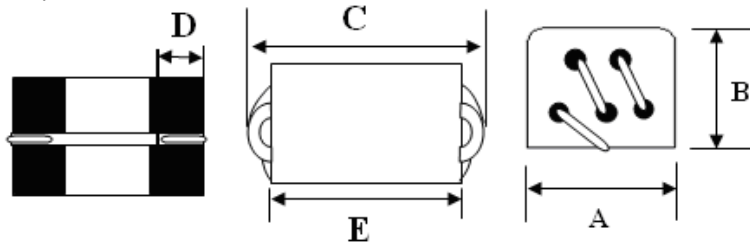

DIMENSIONS & CHARACTERITICS (UNIT: mm)

Part No.	Impedance (Ω) (MIN)		A	B	C	D	E
	25 MHz	100 MHz					
MSH0505-02	128	280	5.0 ± 0.3	4.6 ± 0.3	8.0 Max	1.5 ± 0.5	5.5 ± 0.3
MSH0510-02	300	500	5.0 ± 0.3	4.6 ± 0.3	11.0 Max	2.0 ± 0.5	8.4 ± 0.2

SURFACE MOUNT BEADS / FB TYPE

APPLICATIONS

Computer disk drive and PC Board to filter the EMI from
Outside source, Car radio, Mobile phone and VCRS.

ORDERING CODE

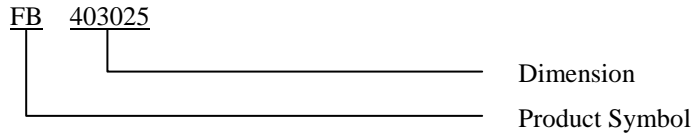

SHAPES

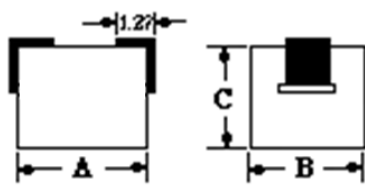

Fig1

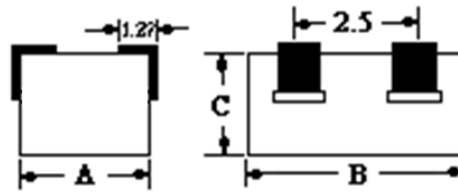

Fig2

DIMENSIONS (UNIT: mm)

Part No.	Fig.	A	B	C	Impedance (Ω) Min	
					25MHz	100MHz
FB 403025	1	4.0 ± 0.20	3.0 ± 0.20	2.5 ± 0.20	25	35
FB 853025	1	8.5 ± 0.25	3.1 ± 0.15	2.5 ± 0.15	60	90
F2B 455625	2	4.5 ± 0.25	5.6 ± 0.20	2.5 ± 0.20	20	35
F2B 855625	2	8.5 ± 0.25	5.6 ± 0.20	2.5 ± 0.20	48	70



CORE MASTER ENTERPRISE CO., LTD.

<http://www.coremaster.com.tw>

WIDE BAND CHOKE / R6H TYPE

APPLICATIONS

- ◆ R6H Type Cores are used for Wide Band Choke. The impedance is substantially resistive and constant.
- ◆ Used in PC boards to filter the EMI from the outsides.
- ◆ For radio and TV, small motor ignition device, computer disk driver, communication equipment, and etc.



ORDERING CODE

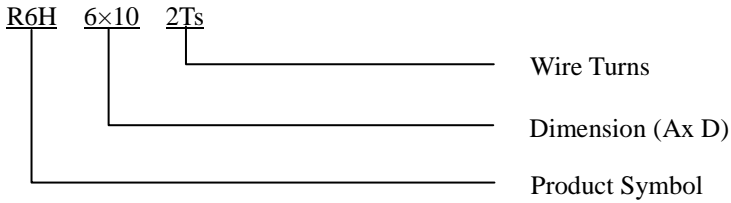

SHAPES

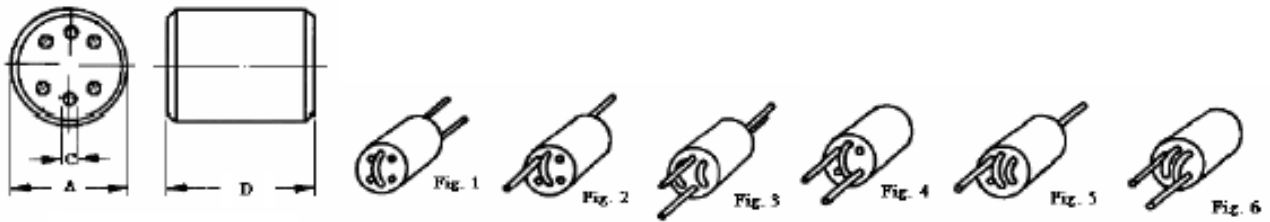

DIMENSIONS & CHARACTERISTICS (UNIT: mm)

Part No.	Turns	Fig.	Impedance (Ω) (MIN)		A	C	D
			25 MHz	100 MHz			
R6H 6×10	1	1	140	320	6.0 ± 0.25	0.80 ± 0.15	10.0 ± 0.4
R6H 6×10	1.5	2	250	480	6.0 ± 0.25	0.80 ± 0.15	10.0 ± 0.4
R6H 6×10	2 x 1.5	3	300	480	6.0 ± 0.25	0.80 ± 0.15	10.0 ± 0.4
R6H 6×10	2	4	300	600	6.0 ± 0.25	0.80 ± 0.15	10.0 ± 0.4
R6H 6×10	2.5	5	350	640	6.0 ± 0.25	0.80 ± 0.15	10.0 ± 0.4
R6H 6×10	3	6	500	780	6.0 ± 0.25	0.80 ± 0.15	10.0 ± 0.4

CORE MASTER ENTERPRISE CO., LTD.



<http://www.coremaster.com.tw>